

tayco.
work well.™

panelink

pricebook

december 8, 2011

Panelink | Terms and Conditions

PRICES

Prices listed herein are for the Panelink product line. Prices are subject to change without notice. Not included in the list prices are special packaging, freight, unloading, unpacking and installation. Possession of this price list does not constitute an offer to sell. Only orders received from authorized Tayco dealers will be processed.

PAYMENT

Terms of payment are net 30 days from date of invoice, upon credit approval.

Remit payment to:

630 Kipling Avenue, Toronto, Ontario, Canada M8Z 5G1

ORDER PLACEMENT AND CONFIRMATION

Tayco requires that all orders be in writing and accompanied by an Order Cover Sheet to avoid errors. When placing orders, please refer to products by their product code and Tayco quotation number, if applicable. Specify all applicable finishes and clearly indicate the total net value of the order on the Purchase Order. Also note the "ship to" address if it is different from the "bill to" address.

Orders should be faxed to:

(416) 252-4467 or (888) 291-0127

You can also e-mail it to: purchaseorders@tayco.com

ORDER ACKNOWLEDGEMENT

Upon receiving a Purchase Order, Tayco will fax an Order Acknowledgement indicating the shipping schedule and a description of the goods ordered. It is the responsibility of the Purchaser to verify the Order Acknowledgement for accuracy.

ORDER CHANGES

All changes to a Purchase Order must be made in writing and are subject to approval by Tayco. Please note: changes may affect the lead-time and may be subject to additional charges. Once production has begun, no changes will be accepted.

ORDER CANCELLATION

All cancellations must be made in writing and are subject to approval by Tayco. Orders in production will incur a minimum charge of 50% (of net) for cancellation. Once production has begun, cancellations will not be accepted.

specifications

Detailed specifications are available upon request. Tayco reserves the right to make changes in materials, dimensions, style or specifications if the changes will improve an item's quality or appearance.

STORAGE

In the event that the Purchaser requests postponement of delivery beyond the acknowledged shipping date (after the goods have become a "work in progress", or at a time when Tayco is about to make shipment), the Purchaser must exercise one of two options:

- > Immediately transfer the goods to a storage facility of the Purchaser's choice at the risk and expense of the Purchaser. Such transfer to storage shall be deemed as delivery to the Purchaser for all purposes, including invoicing and payment.
- > Store the product at Tayco for up to 30 days. Storage fees will be incurred five days after the order is ready for shipment. The storage rate is \$25 per day up to a maximum of \$10,000 net, for orders greater than \$10,000 net, the storage rate will be \$50 per day. On the 31st day after manufacturing completion, the order must be shipped or the Purchaser must make arrangements for the storage of goods.

All goods are payable from the date Tayco has finished manufacturing.

ORDER DELAYS

Tayco's Order Acknowledgement will state a shipping date, which is Tayco's best estimate at the time the order is acknowledged. However, Tayco shall not incur any obligation or liability to the Purchaser for failure to ship by the specified date unless Tayco has agreed to an unequivocal, firm shipping date in a separately signed written document, executed by authorized personnel at Head Office. Tayco holds no liability for any failure to deliver or any delay in delivering or performing any obligation due to any cause outside the reasonable control of Tayco, including but not limited to, fire, flood, bad weather, war, terrorism, civil disturbance, riot, act of government, government regulation, governmental restriction on export or import, currency restriction, labor dispute, strike, plant shutdown, unavailability of materials, equipment failure or failure of supplier, carrier or subcontractor to deliver on time or otherwise perform.

BACK CHARGES

Tayco will not accept charges for expenses incurred by the Purchaser in expediting shipments, for the repair of damage caused by others or for delay of any shipment. Deductions from invoice payments are not permitted unless authorized in writing by Tayco.

FREIGHT TERMS

All goods are sold F.O.B. Tayco, Toronto, Canada, unless otherwise quoted. All shipments are LTL (less than truckload) dock-to-dealer dock, Monday through Friday, 8 a.m. to 5 p.m. The following services may be arranged for an extra charge: delivery after hours on Canadian or U.S. holidays or weekends, residential or inside delivery, delivery to government buildings or schools, use of special equipment (tailgate, pump-truck), delivery to an end user, delivery by appointment or within specific time requirements. Special requests must be noted on the Purchase Order. Tayco will provide customers with an anticipated date of delivery. Every effort is made to adhere to the prescribed delivery date; however, neither Tayco nor the carrier will guarantee or be held responsible in any manner for delays or deviation from the planned delivery date. Drivers are not responsible or permitted to assist in the off-load of product. Tayco is not responsible for any costs incurred for late deliveries, including labor or other charges resulting from unforeseen delays.

FREIGHT CLAIMS

Tayco is not responsible for damage that occurs in transit or in storage. The carrier signs for all goods received in good order from Tayco. It is the Purchaser's responsibility to examine goods upon receipt and file any claims with Tayco. Any damages or shortages must be noted on the bill of lading prior to signing for the delivery. Any claims against Tayco for apparent defects, errors or shortages must be made by the Purchaser, in writing, within five (5) working days after delivery. Failure by the Purchaser to make any claim against Tayco within five days shall constitute acceptance of the goods and waive the right to claim any apparent defects, errors or shortages.

TERMINATION

If at any time Tayco is reasonably led to believe that its interests are imperiled, Tayco may, without prejudice, terminate any order immediately or may defer shipment until the situation is remedied to Tayco's satisfaction. Reasons for order termination include, but are not limited to, the following: default in payment of any sum due to Tayco, breach of any of the terms and conditions of an order or other contract with Tayco, a material change in ownership or form of the purchasing organization or if at any time the Purchaser's financial condition becomes unsatisfactory to Tayco.

RETURN MERCHANDISE

It is not Tayco's policy to accept returned product. In extenuating circumstances the return of product may be approved by Tayco. The Purchaser must request a Return Authorization Form from Tayco. All such returns must be shipped freight prepaid including duty and brokerage fees unless otherwise indicated by Tayco. Standard items are subject to a minimum restocking charge of 50% of the net value of the returned items. COD (cash on delivery) returns will not be accepted.

REPAIRS

Liability for the repair of items will be limited to repair or replacement. Tayco will not issue credit allowances for any repairs without Tayco's prior written consent.

REPLACEMENT PARTS

Replacement parts will be processed as a priority. Please consult with Customer Service for prices and include product codes and descriptions with your Purchase Order.

Panelink | Warranty

Tayco products included in our standard offering are covered by a limited lifetime warranty to the original customer. Tayco warrants that its products are defect free in design, materials and workmanship under normal use and care. Upon inspection, Tayco reserves the right to repair, correct or exchange at our option any product that is defective in material or workmanship. Value of exchanged products will be of equal value of the original item.

Limitations to this warranty include:

- Task Lights are warranted for one year from the date of delivery.
- Keyboard Trays and mechanisms are warranted for three years from the date of delivery.
- Moving parts, which include slides, glides, arms and casters are warranted for five-years from the date of delivery.
- All seating product's warranty is based on single shift for users of up to 275 lbs.
- Seating upholstery and fabrics are warranted for 5 years from the date of delivery.
- Seating control mechanisms and pneumatic cylinders are warranted for 10 years from the date of delivery.
- Flat screen monitor arms are warranted for three years from the date of delivery.
- Veneer products are warranted for 10 years from the date of delivery.
- Electrical components are warranted for 10 years from the date of delivery.

This warranty does not include:

- Ballast and light bulbs.
- Customer's Own Material of any kind.
- Product damage caused by improper installation, accident, negligence, natural disaster, insufficient or excessive electrical supply, environmental conditions, or any unauthorized repair or modification.
- Product damage caused by a carrier or transportation of the product from one location to another.
- Wood veneer colour, grain and stain variations due to the inherent nature of wood.

Panelink | Care and Maintenance

FABRICS

To remove dust and particles, lightly vacuum the fabric surface. Spills and fluid should be immediately blotted. For minor fabric stains and marks use water based fabric solvent, applying light pressure, to lift the dirt and stain. Any use of water and soaps may harm the fabric, causing water stains and damage to the fabric's contents. Do not scrub the fabric with bristle or vacuum brushes as the fabric may pill or tear and the appearance may be permanently affected. Professional steam cleaning is recommended.

LEATHER

Gently dust surface area regularly with a dry, soft cloth. Due to the natural characteristics of this leather, scratches and marks may appear on the surface. This appearance is the "character" of natural leather. Use a clean, slightly damp cloth and clear lukewarm water to clean the entire area. For stains we recommend the use of commercial leather cleaning kits.

LAMINATES

Dust laminated surfaces for regular maintenance. Clean any dirt or stain with a damp cloth. Do not use an excessive amount of water, abrasive cleaners, acids or alkalis and do not scratch or scrape surfaces. For persistent stains and marks use a commercial cleaner, such as Cabinet Magic® or Countertop Magic®, both manufactured by Magic American Corporation.

ACRYLIC TILES AND PANELS (fluted, frosted, bronze)

Dust regularly to keep surfaces free of dust particles. Clean any dirt or stain with a damp cloth. Dry the area using a dry paper cloth. The use of fiber cloths or rags is not recommended as loose particles and debris remaining on the cloth, may scratch or harm the acrylic surface. Do not use other chemical cleaners or window cleaners as their chemical compositions may alter and/or permanently affect the surface appearance.

WOOD VENEER

For everyday maintenance gently wipe with a soft, dry cloth. Clean any dirt or stain with a damp cloth, and a small amount of lukewarm water if necessary. Do not use furniture polishes and waxes. Do not scrub, scratch, scrape or use abrasive cleansers or cleaning pads on any surfaces and trims.

VINYL (trims & bases)

To remove minor scuffmarks and general dirt from bases and connections, use warm water and a soft cloth. Do not use harsh abrasive cleaners, as they may cause permanent scratches on the surface.

PAINTED METALS

Tayco's painted metal products are powder paint coated. To clean these products, use a damp cloth, using only a small amount of lukewarm water if necessary. Dry with a clean dry cloth. To avoid scratching and damaging the painted surface, do not use hard bristled brushes or abrasives.

POLISHED CHROME

Maintain the luster on polished chrome products by gently cleaning with liquid soap and warm water solution. Gently dry and polish the chrome with a clean, soft cloth or rag that is free of any abrasive debris. To buff and polish further, use a commercial chrome cleanser and/or polish to enhance the shine and look. Do not use abrasive cleaners or products, as they may permanently alter the surface appearance.

***The use of harsh cleaners and chemicals may permanently alter the product finish appearance and will void any warranty.**

Panelink Fabric Panels

Basic Fabric Panels, Non Hang-on 30" - 54" High

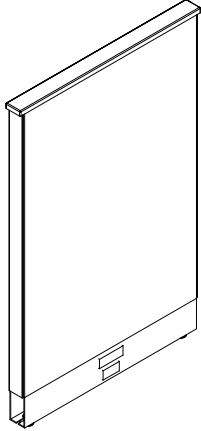

Fabric Options	Gr. 1 Fabric
7-PBF0-3018-N	338
7-PBF0-3024-N	345
7-PBF0-3030-N	365
7-PBF0-3036-N	393
7-PBF0-3042-N	421
7-PBF0-3048-N	432
7-PBF0-3054-N	442
7-PBF0-3060-N	459
7-PBF0-3066-N	484
7-PBF0-3072-N	488
<hr/>	
7-PBF0-3618-N	360
7-PBF0-3624-N	366
7-PBF0-3630-N	389
7-PBF0-3636-N	418
7-PBF0-3642-N	449
7-PBF0-3648-N	461
7-PBF0-3654-N	472
7-PBF0-3660-N	490
7-PBF0-3666-N	515
7-PBF0-3672-N	523
<hr/>	
7-PBF0-4218-N	379
7-PBF0-4224-N	385
7-PBF0-4230-N	410
7-PBF0-4236-N	441
7-PBF0-4242-N	474
7-PBF0-4248-N	486
7-PBF0-4254-N	502
7-PBF0-4260-N	515
7-PBF0-4266-N	544
7-PBF0-4272-N	550
<hr/>	
7-PBF0-4818-N	385
7-PBF0-4824-N	394
7-PBF0-4830-N	419
7-PBF0-4836-N	452
7-PBF0-4842-N	485
7-PBF0-4848-N	496
7-PBF0-4854-N	504
7-PBF0-4860-N	526
7-PBF0-4866-N	554
7-PBF0-4872-N	561
<hr/>	
7-PBF0-5418-N	393
7-PBF0-5424-N	406
7-PBF0-5430-N	431
7-PBF0-5436-N	465
7-PBF0-5442-N	493
7-PBF0-5448-N	509
7-PBF0-5454-N	550
7-PBF0-5460-N	570
7-PBF0-5466-N	607
7-PBF0-5472-N	612

	Width (inches)	Weight (lbs.)
	18	10
	24	14
	30	18
	36	22
	42	26
	48	30
	54	34
	60	38
	66	42
	72	46
<hr/>		
	18	13
	24	17
	30	21
	36	25
	42	29
	48	33
	54	37
	60	41
	66	45
	72	49
<hr/>		
	18	15
	24	19
	30	23
	36	27
	42	31
	48	35
	54	39
	60	43
	66	47
	72	51
<hr/>		
	18	18
	24	22
	30	25
	36	30
	42	34
	48	38
	54	42
	60	46
	66	50
	72	54
<hr/>		
	18	20
	24	24
	30	28
	36	32
	42	36
	48	40
	54	44
	60	46
	66	52
	72	56

Fabric Panels

Basic Fabric Panels, Non Hang-on:

- Monolithic acoustical panel
- No hang-on capabilities - Will not support surfaces and overhead cabinets
- Includes PVC raceway
- Includes panel connectors
- Electrics sold separately

When Ordering Fabric Panels Please Specify:

- Fabric color
- Wood stain color
- Raceway color

Sample Code

7	PBFO	42	36	N
Product Family	Product Code	Height	Width	Product Modifier

Upgrades:

- Fabric Grade 2 Upgrade: \$43.00/panel
- Maple Top Cap Upgrade: \$43.00/panel

Panelink Fabric Panels

Basic Fabric Panels, Non Hang-on 60" - 84" High

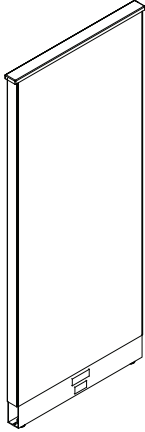

Fabric Options	Gr. 1 Fabric	Width (inches)	Weight (lbs.)
7-PBF0-6018-N	400	18	23
7-PBF0-6024-N	413	24	27
7-PBF0-6030-N	439	30	31
7-PBF0-6036-N	473	36	35
7-PBF0-6042-N	503	42	39
7-PBF0-6048-N	521	48	43
7-PBF0-6054-N	576	54	44
7-PBF0-6060-N	596	60	51
7-PBF0-6066-N	636	66	55
7-PBF0-6072-N	644	72	59
7-PBF0-6618-N	417	18	25
7-PBF0-6624-N	431	24	29
7-PBF0-6630-N	456	30	33
7-PBF0-6636-N	490	36	37
7-PBF0-6642-N	524	42	41
7-PBF0-6648-N	570	48	45
7-PBF0-6654-N	583	54	49
7-PBF0-6660-N	603	60	53
7-PBF0-6666-N	644	66	57
7-PBF0-6672-N	651	72	61
7-PBF0-7218-N	432	18	28
7-PBF0-7224-N	445	24	32
7-PBF0-7230-N	464	30	36
7-PBF0-7236-N	567	36	40
7-PBF0-7242-N	585	42	44
7-PBF0-7248-N	600	48	48
7-PBF0-7254-N	616	54	52
7-PBF0-7260-N	636	60	56
7-PBF0-8418-N	490	18	33
7-PBF0-8424-N	507	24	37
7-PBF0-8430-N	528	30	41
7-PBF0-8436-N	654	36	45
7-PBF0-8442-N	678	42	49
7-PBF0-8448-N	698	48	53
7-PBF0-8454-N	734	54	57
7-PBF0-8460-N	745	60	61

Fabric Panels

Basic Fabric Panels, Non Hang-on:

- Monolithic acoustical panel
- No hang-on capabilities - Will not support surfaces and overhead cabinets
- Includes PVC raceway
- Includes panel connectors
- Electrics sold separately

When Ordering Fabric Panels Please Specify:

- Fabric color
- Wood stain color
- Raceway color

Sample Code

7	PBFO	42	36	N
Product Family	Product Code	Height	Width	Product Modifier

Upgrades:

- Fabric Grade 2 Upgrade: \$43.00/panel
- Maple Top Cap Upgrade: \$43.00/panel

Panelink Fabric Panels

Basic Fabric Panels, With Hang-on 30" - 54" High

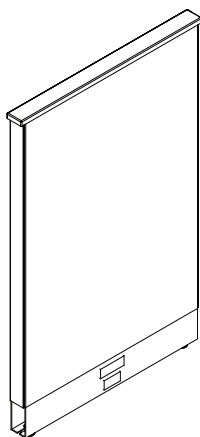

Fabric Options	Gr. 1 Fabric
7-PBF0-3018-H	381
7-PBF0-3024-H	404
7-PBF0-3030-H	427
7-PBF0-3036-H	455
7-PBF0-3042-H	480
7-PBF0-3048-H	491
7-PBF0-3054-H	502
7-PBF0-3060-H	517
7-PBF0-3066-H	542
7-PBF0-3072-H	580
7-PBF0-3618-H	406
7-PBF0-3624-H	431
7-PBF0-3630-H	454
7-PBF0-3636-H	486
7-PBF0-3642-H	513
7-PBF0-3648-H	523
7-PBF0-3654-H	534
7-PBF0-3660-H	551
7-PBF0-3666-H	579
7-PBF0-3672-H	586
7-PBF0-4218-H	432
7-PBF0-4224-H	460
7-PBF0-4230-H	485
7-PBF0-4236-H	517
7-PBF0-4242-H	547
7-PBF0-4248-H	559
7-PBF0-4254-H	571
7-PBF0-4260-H	586
7-PBF0-4266-H	616
7-PBF0-4272-H	624
7-PBF0-4818-H	445
7-PBF0-4824-H	473
7-PBF0-4830-H	498
7-PBF0-4836-H	529
7-PBF0-4842-H	562
7-PBF0-4848-H	572
7-PBF0-4854-H	590
7-PBF0-4860-H	606
7-PBF0-4866-H	637
7-PBF0-4872-H	646
7-PBF0-5418-H	472
7-PBF0-5424-H	493
7-PBF0-5430-H	519
7-PBF0-5436-H	552
7-PBF0-5442-H	582
7-PBF0-5448-H	597
7-PBF0-5454-H	628
7-PBF0-5460-H	658
7-PBF0-5466-H	691
7-PBF0-5472-H	702

Width (inches)	Weight (lbs.)
18	13
24	17
30	21
36	25
42	29
48	33
54	37
60	41
66	45
72	49
18	16
24	20
30	24
36	28
42	32
48	36
54	40
60	44
66	48
72	52
18	19
24	23
30	27
36	31
42	35
48	39
54	43
60	47
66	51
72	55
18	22
24	26
30	30
36	35
42	38
48	42
54	46
60	50
66	54
72	58
18	25
24	29
30	33
36	37
42	41
48	45
54	49
60	53
66	57
72	61

Fabric Panels

Basic Fabric Panels, Hang-on:

Monolithic acoustical panel
 Hang-on capabilities at any height
 Includes PVC raceway
 Includes panel connectors
 Electrics sold separately

When Ordering Fabric Panels Please Specify:

Fabric color
 Wood stain color
 Raceway color

Upgrades:

Fabric Grade 2 Upgrade: \$43.00/panel
 Maple Top Cap Upgrade: \$43.00/panel

Sample Code

7	PBFO	42	36	H
Product Family	Product Code	Height	Width	Product Modifier

Panelink Fabric Panels

Basic Fabric Panels, With Hang-on 60" - 84" High

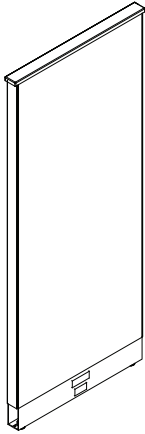

Fabric Options	Gr. 1 Fabric	Width (inches)	Weight (lbs.)
7-PBF0-6018-H	491	18	28
7-PBF0-6024-H	511	24	32
7-PBF0-6030-H	537	30	36
7-PBF0-6036-H	571	36	40
7-PBF0-6042-H	602	42	44
7-PBF0-6048-H	620	48	48
7-PBF0-6054-H	636	54	52
7-PBF0-6060-H	692	60	56
7-PBF0-6066-H	734	66	60
7-PBF0-6072-H	743	72	64
<hr/>			
7-PBF0-6618-H	524	18	31
7-PBF0-6624-H	537	24	35
7-PBF0-6630-H	564	30	39
7-PBF0-6636-H	598	36	43
7-PBF0-6642-H	629	42	47
7-PBF0-6648-H	677	48	51
7-PBF0-6654-H	694	54	55
7-PBF0-6660-H	712	60	59
7-PBF0-6666-H	746	66	63
7-PBF0-6672-H	759	72	67
<hr/>			
7-PBF0-7218-H	550	18	34
7-PBF0-7224-H	564	24	38
7-PBF0-7230-H	579	30	42
7-PBF0-7236-H	681	36	46
7-PBF0-7242-H	703	42	50
7-PBF0-7248-H	717	48	54
7-PBF0-7254-H	734	54	58
7-PBF0-7260-H	753	60	62
<hr/>			
7-PBF0-8418-H	628	18	40
7-PBF0-8424-H	643	24	44
7-PBF0-8430-H	667	30	48
7-PBF0-8436-H	790	36	52
7-PBF0-8442-H	814	42	56
7-PBF0-8448-H	834	48	60
7-PBF0-8454-H	865	54	64
7-PBF0-8460-H	884	60	68

Fabric Panels

Basic Fabric Panels, Hang-on:

Monolithic acoustical panel
 Hang-on capabilities at any height
 Includes PVC raceway
 Includes panel connectors
 Electrics sold separately

Upgrades:

Fabric Grade 2 Upgrade: \$43.00/panel
 Maple Top Cap Upgrade: \$43.00/panel

When Ordering Fabric Panels Please Specify:

Fabric color
 Wood stain color
 Raceway color

Sample Code

7	PBFO	66	36	H
Product Family	Product Code	Height	Width	Product Modifier

Panelink Fabric Panels

Radiused Fabric Panels, Non Hang-on

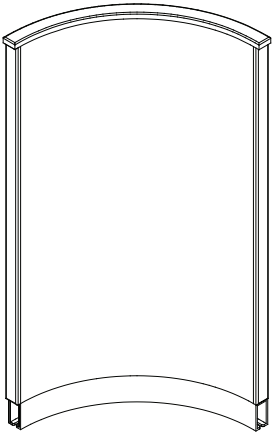

Fabric Options	Gr. 1 Fabric
7-PRF0-3024-N	1025
7-PRF0-3624-N	1077
7-PRF0-4224-N	1097
7-PRF0-4824-N	1210
7-PRF0-5424-N	1229
7-PRF0-6024-N	1241
7-PRF0-6624-N	1275
7-PRF0-7224-N	1301
7-PRF0-8424-N	1343

Width (inches)	Weight (lbs.)
24	32
24	34
24	36
24	38
24	40
24	42
24	44
24	46
24	50

Fabric Panels

Radiused Fabric Panels, Non Hang-on:

Monolithic acoustical panel
 Includes PVC raceway
 Includes panel connectors
 Electrics sold separately
 Cannot be powered - pass-through electrics only

Upgrades:

Fabric Grade 2 Upgrade: \$43.00/panel
 Maple Top Cap Upgrade: \$43.00/panel

When Ordering Fabric Panels Please Specify:

Fabric color
 Wood stain color
 Raceway color

Sample Code

7	PRFO	42	24	N
Product Family	Product Code	Height	Width	Product Modifier

Panelink Fabric Panels

Radiused Fabric Panels, With Hang-on

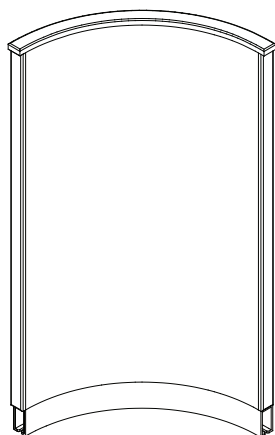

Fabric Options	Gr. 1 Fabric	Width (inches)	Weight (lbs.)
7-PRF0-3024-H	1091	24	35
7-PRF0-3624-H	1103	24	38
7-PRF0-4224-H	1152	24	40
7-PRF0-4248-H	1327	48	40
7-PRF0-4260-H	1340	60	40
7-PRF0-4824-H	1287	24	45
7-PRF0-5424-H	1321	24	45
7-PRF0-6024-H	1337	24	48
7-PRF0-6624-H	1382	24	51
7-PRF0-7224-H	1417	24	53
7-PRF0-8424-H	1482	24	58

Fabric Panels

Radiused Fabric Panels, Hang-on:

- Monolithic acoustical panel
- Hang-on capabilities at any height
- Includes PVC raceway
- Includes panel connectors
- Electrics sold separately
- Cannot be powered - pass-through electrics only

When Ordering Fabric Panels Please Specify:

- Fabric color
- Wood stain color
- Raceway color

Sample Code

7	PRFO	66	24	H
Product Family	Product Code	Height	Width	Product Modifier

Panelink Glazed Panels

Tayco Glazed panels are available with a wood.

Tayco offers 2 types of glazing: Bronzed and Frosted

Bronzed Glazing is a slightly tinted yet see through

Frosted Glazing is white in color and is not see through

Standard glazing is bronze. Please apply a \$54.00 up-charge per panel for frosted glazing.

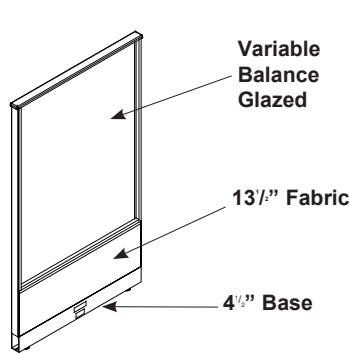

G1 Panel

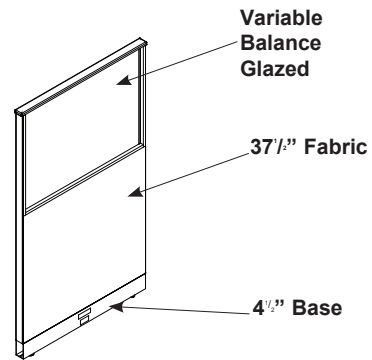

G2 Panel

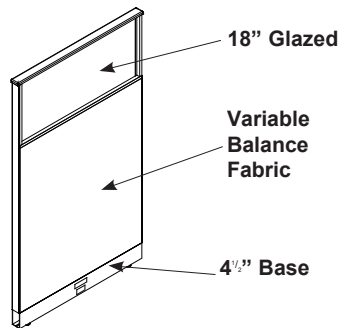

G3 Panel

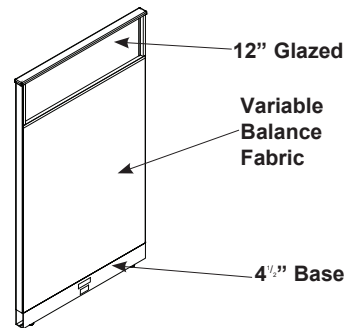

G4 Panel

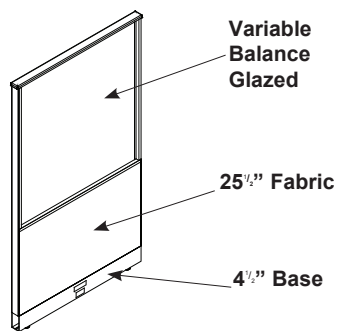

G5 Panel

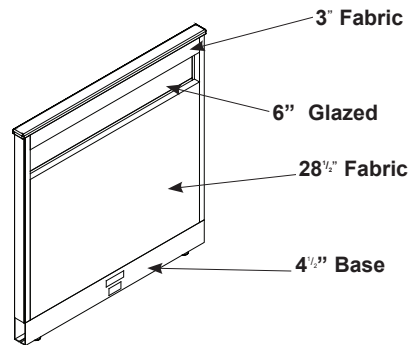

G6 Panel

Panelink Glazed Panels

G1 Glazed Panels, Non Hang-on 54" - 84" High

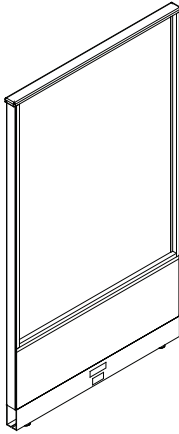

Fabric Options	Gr. 1 Fabric	Width (inches)	Weight (lbs.)
7-PBG1-5418-N	549	18	17
7-PBG1-5424-N	599	24	21
7-PBG1-5430-N	651	30	25
7-PBG1-5436-N	700	36	29
7-PBG1-5442-N	748	42	33
7-PBG1-5448-N	813	48	36
<hr/>			
7-PBG1-6018-N	630	18	18
7-PBG1-6024-N	662	24	22
7-PBG1-6030-N	717	30	26
7-PBG1-6036-N	774	36	30
7-PBG1-6042-N	834	42	35
7-PBG1-6048-N	888	48	39
<hr/>			
7-PBG1-6618-N	651	18	20
7-PBG1-6624-N	687	24	24
7-PBG1-6630-N	738	30	28
7-PBG1-6636-N	791	36	33
7-PBG1-6642-N	865	42	37
7-PBG1-6648-N	921	48	41
<hr/>			
7-PBG1-7218-N	675	18	21
7-PBG1-7224-N	705	24	26
7-PBG1-7230-N	742	30	30
7-PBG1-7236-N	806	36	35
<hr/>			
7-PBG1-8418-N	677	18	24
7-PBG1-8424-N	721	24	29
7-PBG1-8430-N	748	30	34
7-PBG1-8436-N	831	36	39

Glazed Panels

Glazed Panels, Non Hang-on:

- Monolithic acoustical panel
- No hang-on capabilities
- Includes PVC raceway
- Includes panel connectors
- Electrics sold separately
- Frosted glazing available - \$54 list up-charge per panel

When Ordering Glazed Panels Please Specify:

- Fabric color
- Wood stain color
- Glazing color
- Raceway color

Sample Code

7	PBG1	66	36	N
Product Family	Product Code	Height	Width	Product Modifier

Panelink Glazed Panels

G2 Glazed Panels, Non Hang-on 54" - 84" High

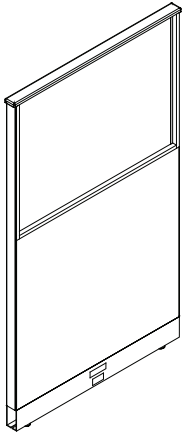

Fabric Options	Gr. 1 Fabric
7-PBG2-5418-N	549
7-PBG2-5424-N	599
7-PBG2-5430-N	651
7-PBG2-5436-N	700
7-PBG2-5442-N	748
7-PBG2-5448-N	813
7-PBG2-5454-N	820
7-PBG2-5460-N	849
<hr/>	
7-PBG2-6018-N	630
7-PBG2-6024-N	662
7-PBG2-6030-N	717
7-PBG2-6036-N	774
7-PBG2-6042-N	834
7-PBG2-6048-N	888
7-PBG2-6054-N	904
7-PBG2-6060-N	920
<hr/>	
7-PBG2-6618-N	651
7-PBG2-6624-N	687
7-PBG2-6630-N	738
7-PBG2-6636-N	791
7-PBG2-6642-N	865
7-PBG2-6648-N	921
7-PBG2-6654-N	933
7-PBG2-6660-N	960
<hr/>	
7-PBG2-7218-N	675
7-PBG2-7224-N	705
7-PBG2-7230-N	742
7-PBG2-7236-N	806
7-PBG2-7242-N	888
7-PBG2-7248-N	931
7-PBG2-7254-N	957
7-PBG2-7260-N	967
<hr/>	
7-PBG2-8418-N	677
7-PBG2-8424-N	721
7-PBG2-8430-N	748
7-PBG2-8436-N	831
7-PBG2-8442-N	903
7-PBG2-8448-N	949
7-PBG2-8454-N	957
7-PBG2-8460-N	985

Width (inches) Weight (lbs.)

18	20
24	24
30	29
36	34
42	40
48	45
54	50
60	55
<hr/>	
18	21
24	26
30	31
36	36
42	42
48	47
54	52
60	57
<hr/>	
18	22
24	28
30	33
36	39
42	44
48	49
54	55
60	60
<hr/>	
18	24
24	29
30	35
36	40
42	46
48	52
54	57
60	63
<hr/>	
18	27
24	33
30	39
36	44
42	50
48	56
54	62
60	68

Glazed Panels

Glazed Panels, Non Hang-on:

Glazed panel
Includes PVC raceway
Includes panel connectors
Electrics sold separately
Frosted glazing available

Upgrades:

Fabric Grade 2 Upgrade: \$43.00/panel
Maple Top Cap Upgrade: \$43.00/panel

Glazed Panel Upgrades:
Frosted or Clear: \$54.00/panel

When Ordering Glazed Panels Please Specify:

Fabric color
Wood stain color
Glazing color
Raceway color

Sample Code

7	PBG2	42	36	N
Product Family	Product Code	Height	Width	Product Modifier

Panelink Glazed Panels

G2 Glazed Panels, Hang-on 54" - 84" High

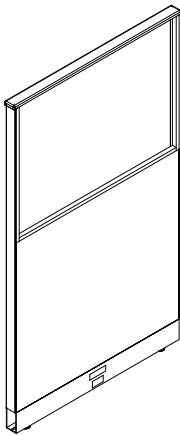

Fabric Options	Gr. 1 Fabric	Width (inches)	Weight (lbs.)
7-PBG2-5418-H	606	18	24
7-PBG2-5424-H	674	24	29
7-PBG2-5430-H	724	30	34
7-PBG2-5436-H	774	36	39
7-PBG2-5442-H	821	42	44
7-PBG2-5448-H	886	48	49
7-PBG2-5454-H	896	54	55
7-PBG2-5460-H	920	60	59
7-PBG2-6018-H	686	18	25
7-PBG2-6024-H	737	24	30
7-PBG2-6030-H	791	30	35
7-PBG2-6036-H	846	36	41
7-PBG2-6042-H	907	42	46
7-PBG2-6048-H	962	48	51
7-PBG2-6054-H	970	54	56
7-PBG2-6060-H	994	60	62
7-PBG2-6618-H	712	18	26
7-PBG2-6624-H	762	24	32
7-PBG2-6630-H	813	30	37
7-PBG2-6636-H	865	36	43
7-PBG2-6642-H	938	42	48
7-PBG2-6648-H	996	48	53
7-PBG2-6654-H	1012	54	59
7-PBG2-6660-H	1034	60	64
7-PBG2-7218-H	740	18	28
7-PBG2-7224-H	780	24	34
7-PBG2-7230-H	817	30	39
7-PBG2-7236-H	880	36	45
7-PBG2-7242-H	962	42	50
7-PBG2-7248-H	1004	48	56
7-PBG2-7254-H	1012	54	61
7-PBG2-7260-H	1040	60	67
7-PBG2-8418-H	760	18	31
7-PBG2-8424-H	793	24	37
7-PBG2-8430-H	823	30	43
7-PBG2-8436-H	906	36	49
7-PBG2-8442-H	976	42	55
7-PBG2-8448-H	1022	48	61
7-PBG2-8454-H	1036	54	67
7-PBG2-8460-H	1060	60	72

Glazed Panels

Glazed Panels, Hang-on:

- Glazed panel
- Hang-on capabilities
- Includes PVC raceway
- Includes panel connectors
- Electrics sold separately
- Frosted glazing available

Upgrades:

- Fabric Grade 2 Upgrade: \$43.00/panel
- Maple Top Cap Upgrade: \$43.00/panel

- Glazed Panel Upgrades:
- Frosted or Clear: \$54.00/panel

When Ordering Glazed Panels Please Specify:

- Fabric color
- Wood stain color
- Glazing color
- Raceway color

Sample Code

7	PBG2	66	36	H
Product Family	Product Code	Height	Width	Product Modifier

Panelink Glazed Panels

G3 Glazed Panels, Non Hang-on 54" - 84" High

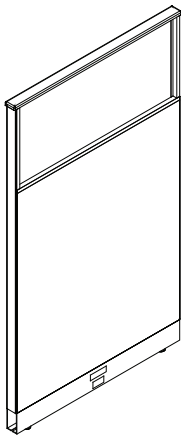

Fabric Options	Gr. 1 Fabric
7-PBG3-5418-N	549
7-PBG3-5424-N	599
7-PBG3-5430-N	651
7-PBG3-5436-N	700
7-PBG3-5442-N	748
7-PBG3-5448-N	813
7-PBG3-5454-N	820
7-PBG3-5460-N	849
<hr/>	
7-PBG3-6618-N	651
7-PBG3-6624-N	687
7-PBG3-6630-N	738
7-PBG3-6636-N	791
7-PBG3-6642-N	865
7-PBG3-6648-N	921
7-PBG3-6654-N	933
7-PBG3-6660-N	960
<hr/>	
7-PBG3-7218-N	675
7-PBG3-7224-N	705
7-PBG3-7230-N	742
7-PBG3-7236-N	806
7-PBG3-7242-N	888
7-PBG3-7248-N	931
7-PBG3-7254-N	957
7-PBG3-7260-N	967
<hr/>	
7-PBG3-8418-N	677
7-PBG3-8424-N	721
7-PBG3-8430-N	748
7-PBG3-8436-N	831
7-PBG3-8442-N	903
7-PBG3-8448-N	949
7-PBG3-8454-N	957
7-PBG3-8460-N	985

Width (inches)	Weight (lbs.)
18	19
24	24
30	29
36	34
42	40
48	45
54	50
60	55
<hr/>	
18	24
24	29
30	34
36	39
42	45
48	50
54	55
60	60
<hr/>	
18	27
24	31
30	37
36	42
42	47
48	52
54	57
60	63
<hr/>	
18	32
24	36
30	41
36	47
42	52
48	57
54	62
60	68

Glazed Panels

Glazed Panels, Non Hang-on:

- Glazed panel
- Includes PVC raceway
- Includes panel connectors
- Electrics sold separately
- Frosted glazing available

Upgrades:
Fabric Grade 2 Upgrade: \$43.00/panel
Maple Top Cap Upgrade: \$43.00/panel
Glazed Panel Upgrades:
Frosted or Clear: \$54.00/panel

When Ordering Glazed Panels Please Specify:

- Fabric color
- Wood stain color
- Glazing color
- Raceway color

Sample Code

7	PBG3	42	36	N
Product Family	Product Code	Height	Width	Product Modifier

Panelink Glazed Panels

G3 Glazed Panels, Hang-on 54" - 84" High

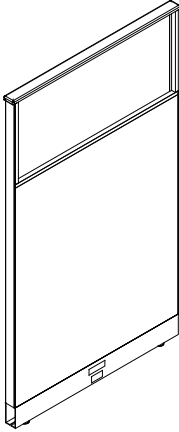

Fabric Options	Gr. 1 Fabric	Width (inches)	Weight (lbs.)
7-PBG3-5418-H	640	18	22
7-PBG3-5424-H	674	24	27
7-PBG3-5430-H	724	30	32
7-PBG3-5436-H	774	36	38
7-PBG3-5442-H	821	42	43
7-PBG3-5448-H	886	48	48
7-PBG3-5454-H	896	54	53
7-PBG3-5460-H	920	60	58
7-PBG3-6618-H	712	18	28
7-PBG3-6624-H	762	24	33
7-PBG3-6630-H	813	30	39
7-PBG3-6636-H	865	36	44
7-PBG3-6642-H	938	42	49
7-PBG3-6648-H	996	48	54
7-PBG3-6654-H	1012	54	59
7-PBG3-6660-H	1034	60	65
7-PBG3-7218-H	740	18	31
7-PBG3-7224-H	780	24	36
7-PBG3-7230-H	817	30	42
7-PBG3-7236-H	880	36	47
7-PBG3-7242-H	962	42	52
7-PBG3-7248-H	1004	48	57
7-PBG3-7254-H	1012	54	63
7-PBG3-7260-H	1040	60	68
7-PBG3-8418-H	760	18	34
7-PBG3-8424-H	793	24	43
7-PBG3-8430-H	823	30	48
7-PBG3-8436-H	906	36	53
7-PBG3-8442-H	976	42	58
7-PBG3-8448-H	1022	48	64
7-PBG3-8454-H	1036	54	69
7-PBG3-8460-H	1060	60	74

Glazed Panels

Glazed Panels, Hang-on:

- Glazed panel
- Hang-on capabilities
- Includes PVC raceway
- Includes panel connectors
- Electrics sold separately
- Frosted glazing available

Upgrades:

- Fabric Grade 2 Upgrade: \$43.00/panel
- Maple Top Cap Upgrade: \$43.00/panel

- Glazed Panel Upgrades:
- Frosted or Clear: \$54.00/panel

When Ordering Glazed Panels Please Specify:

- Fabric color
- Wood stain color
- Glazing color
- Raceway color

Sample Code

7	PBG3	66	36	H
Product Family	Product Code	Height	Width	Product Modifier

Panelink Glazed Panels

G4 Glazed Panels, Non Hang-on 60" - 84" High

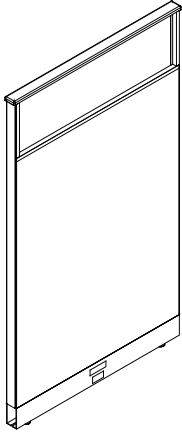

Fabric Options	Gr. 1 Fabric
7-PBG4-6018-N	630
7-PBG4-6024-N	662
7-PBG4-6030-N	717
7-PBG4-6036-N	774
7-PBG4-6042-N	834
7-PBG4-6048-N	888
7-PBG4-6054-N	904
7-PBG4-6060-N	920
7-PBG4-6618-N	651
7-PBG4-6624-N	687
7-PBG4-6630-N	738
7-PBG4-6636-N	791
7-PBG4-6642-N	865
7-PBG4-6648-N	921
7-PBG4-6654-N	933
7-PBG4-6660-N	960
7-PBG4-7218-N	675
7-PBG4-7224-N	705
7-PBG4-7230-N	742
7-PBG4-7236-N	806
7-PBG4-7242-N	888
7-PBG4-7248-N	931
7-PBG4-7254-N	957
7-PBG4-7260-N	967
7-PBG4-8418-N	677
7-PBG4-8424-N	721
7-PBG4-8430-N	748
7-PBG4-8436-N	831
7-PBG4-8442-N	903
7-PBG4-8448-N	949
7-PBG4-8454-N	957
7-PBG4-8460-N	985

Width (inches) Weight (lbs.)

18	22
24	27
30	32
36	37
42	42
48	47
54	52
60	57
18	24
24	29
30	34
36	39
42	45
48	50
54	55
60	60
18	27
24	32
30	37
36	42
42	47
48	52
54	57
60	62
18	32
24	37
30	42
36	47
42	52
48	57
54	62
60	66

Glazed Panels

Glazed Panels, Non Hang-on:

- Glazed panel
- Includes PVC raceway
- Includes panel connectors
- Electrics sold separately
- Frosted glazing available

Upgrades:

- Fabric Grade 2 Upgrade: \$43.00/panel
- Maple Top Cap Upgrade: \$43.00/panel

- Glazed Panel Upgrades:
- Frosted or Clear: \$54.00/panel

When Ordering Glazed Panels Please Specify:

- Fabric color
- Wood stain color
- Glazing color
- Raceway color

Sample Code

7	PBG4	42	36	N
Product Family	Product Code	Height	Width	Product Modifier

Panelink Glazed Panels

G4 Glazed Panels, Hang-on 60" - 84" High

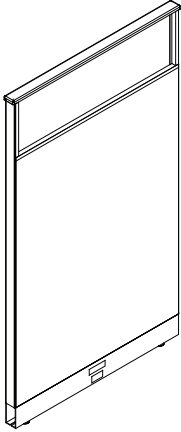

Fabric Options	Gr. 1 Fabric	Width (inches)	Weight (lbs.)
7-PBG4-6018-H	686	18	27
7-PBG4-6024-H	737	24	32
7-PBG4-6030-H	791	30	37
7-PBG4-6036-H	846	36	42
7-PBG4-6042-H	907	42	47
7-PBG4-6048-H	962	48	52
7-PBG4-6054-H	970	54	57
7-PBG4-6060-H	994	60	62
7-PBG4-6618-H	712	18	30
7-PBG4-6624-H	762	24	35
7-PBG4-6630-H	813	30	40
7-PBG4-6636-H	865	36	45
7-PBG4-6642-H	938	42	50
7-PBG4-6648-H	996	48	55
7-PBG4-6654-H	1012	54	60
7-PBG4-6660-H	1034	60	65
7-PBG4-7218-H	740	18	33
7-PBG4-7224-H	780	24	38
7-PBG4-7230-H	817	30	43
7-PBG4-7236-H	880	36	48
7-PBG4-7242-H	962	42	53
7-PBG4-7248-H	1004	48	58
7-PBG4-7254-H	1012	54	63
7-PBG4-7260-H	1040	60	68
7-PBG4-8418-H	760	18	39
7-PBG4-8424-H	793	24	44
7-PBG4-8430-H	823	30	49
7-PBG4-8436-H	906	36	54
7-PBG4-8442-H	976	42	59
7-PBG4-8448-H	1022	48	64
7-PBG4-8454-H	1036	54	69
7-PBG4-8460-H	1060	60	74

Glazed Panels

Glazed Panels, Hang-on:

- Glazed panel
- Hang-on capabilities
- Includes PVC raceway
- Includes panel connectors
- Electrics sold separately
- Frosted glazing available

Upgrades:

- Fabric Grade 2 Upgrade: \$43.00/panel
- Maple Top Cap Upgrade: \$43.00/panel

- Glazed Panel Upgrades:
- Frosted or Clear: \$54.00/panel

When Ordering Glazed Panels Please Specify:

- Fabric color
- Wood stain color
- Glazing color
- Raceway color

Sample Code

7	PBG4	66	36	H
Product Family	Product Code	Height	Width	Product Modifier

Panelink Glazed Panels

G5 Glazed Panels, Non Hang-on 54" - 84" High

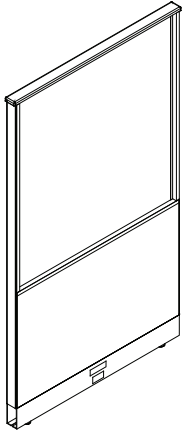

Fabric Options	Gr. 1 Fabric
7-PBG5-5418-N	549
7-PBG5-5424-N	599
7-PBG5-5430-N	651
7-PBG5-5436-N	700
7-PBG5-5442-N	748
7-PBG5-5448-N	813
7-PBG5-5454-N	820
7-PBG5-5460-N	849
7-PBG5-6018-N	630
7-PBG5-6024-N	662
7-PBG5-6030-N	717
7-PBG5-6036-N	774
7-PBG5-6042-N	834
7-PBG5-6048-N	888
7-PBG5-6054-N	904
7-PBG5-6060-N	920
7-PBG5-6618-N	651
7-PBG5-6624-N	687
7-PBG5-6630-N	738
7-PBG5-6636-N	791
7-PBG5-6642-N	865
7-PBG5-6648-N	921
7-PBG5-6654-N	933
7-PBG5-6660-N	960
7-PBG5-7218-N	675
7-PBG5-7224-N	705
7-PBG5-7230-N	742
7-PBG5-7236-N	806
7-PBG5-7242-N	888
7-PBG5-7248-N	931
7-PBG5-7254-N	957
7-PBG5-7260-N	967
7-PBG5-8418-N	677
7-PBG5-8424-N	721
7-PBG5-8430-N	748
7-PBG5-8436-N	831
7-PBG5-8442-N	903
7-PBG5-8448-N	949
7-PBG5-8454-N	957
7-PBG5-8460-N	985

Width (inches)	Weight (lbs.)
18	17
24	23
30	28
36	33
42	39
48	44
54	50
60	55
18	19
24	24
30	30
36	35
42	41
48	47
54	55
60	58
18	20
24	26
30	32
36	37
42	43
48	49
54	55
60	61
18	22
24	28
30	34
36	39
42	45
48	51
54	57
60	63
18	25
24	31
30	37
36	44
42	50
48	56
54	62
60	69

Glazed Panels

Glazed Panels, Non Hang-on:

- Glazed panel
- Includes PVC raceway
- Includes panel connectors
- Electrics sold separately
- Frosted glazing available

Upgrades:

- Fabric Grade 2 Upgrade: \$43.00/panel
- Maple Top Cap Upgrade: \$43.00/panel

- Glazed Panel Upgrades:
- Frosted or Clear: \$54.00/panel

When Ordering Glazed Panels Please Specify:

- Fabric color
- Wood stain color
- Glazing color
- Raceway color

Sample Code

7	PBG5	42	36	N
Product Family	Product Code	Height	Width	Product Modifier

Panelink Glazed Panels

G5 Glazed Panels, Hang-on 54" - 84" High

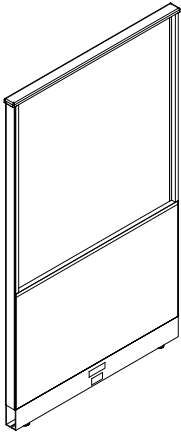

Fabric Options	Gr. 1 Fabric	Width (inches)	Weight (lbs.)
7-PBG5-5418-H	640	18	20
7-PBG5-5424-H	674	24	26
7-PBG5-5430-H	724	30	31
7-PBG5-5436-H	774	36	36
7-PBG5-5442-H	821	42	42
7-PBG5-5448-H	886	48	47
7-PBG5-5454-H	896	54	53
7-PBG5-5460-H	920	60	58
7-PBG5-6018-H	686	18	22
7-PBG5-6024-H	737	24	27
7-PBG5-6030-H	791	30	33
7-PBG5-6036-H	846	36	38
7-PBG5-6042-H	907	42	44
7-PBG5-6048-H	962	48	50
7-PBG5-6054-H	970	54	55
7-PBG5-6060-H	994	60	61
7-PBG5-6618-H	712	18	23
7-PBG5-6624-H	762	24	29
7-PBG5-6630-H	813	30	35
7-PBG5-6636-H	865	36	40
7-PBG5-6642-H	938	42	46
7-PBG5-6648-H	996	48	52
7-PBG5-6654-H	1012	54	58
7-PBG5-6660-H	1034	60	64
7-PBG5-7218-H	740	18	25
7-PBG5-7224-H	780	24	31
7-PBG5-7230-H	817	30	37
7-PBG5-7236-H	880	36	42
7-PBG5-7242-H	962	42	48
7-PBG5-7248-H	1004	48	54
7-PBG5-7254-H	1012	54	60
7-PBG5-7260-H	1040	60	66
7-PBG5-8418-H	760	18	28
7-PBG5-8424-H	793	24	34
7-PBG5-8430-H	823	30	40
7-PBG5-8436-H	906	36	47
7-PBG5-8442-H	976	42	53
7-PBG5-8448-H	1022	48	59
7-PBG5-8454-H	1036	54	65
7-PBG5-8460-H	1060	60	72

Glazed Panels

Glazed Panels, Hang-on:

- Glazed panel
- Hang-on capabilities
- Includes PVC raceway
- Includes panel connectors
- Electrics sold separately
- Frosted glazing available

Upgrades:

- Fabric Grade 2 Upgrade: \$43.00/panel
- Maple Top Cap Upgrade: \$43.00/panel

- Glazed Panel Upgrades:
- Frosted or Clear: \$54.00/panel

When Ordering Glazed Panels Please Specify:

- Fabric color
- Wood stain color
- Glazing color
- Raceway color

Sample Code

7	PBG5	66	36	H
Product Family	Product Code	Height	Width	Product Modifier

Panelink Glazed Panels

G6 Glazed Panels, Hang-on 42" High

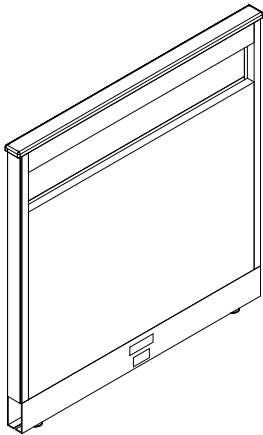

Fabric Options	Gr. 1 Fabric	Width (inches)	Weight (lbs.)
7-PBG6-4218-H	622	18	29
7-PBG6-4224-H	674	24	33
7-PBG6-4230-H	724	30	37
7-PBG6-4236-H	774	36	41
7-PBG6-4242-H	821	42	45
7-PBG6-4248-H	886	48	49
7-PBG6-4254-H	897	54	53
7-PBG6-4260-H	923	60	57
7-PBG6-4266-H	947	66	61
7-PBG6-4272-H	960	72	65

Glazed Panels

Glazed Panels, Hang-on:

- Glazed panel
- Hang-on capabilities
- Includes PVC raceway
- Includes panel connectors
- Electrics sold separately
- Frosted glazing available

Upgrades:

- Fabric Grade 2 Upgrade: \$43.00/panel
- Maple Top Cap Upgrade: \$43.00/panel

- Glazed Panel Upgrades:
- Frosted or Clear: \$54.00/panel

When Ordering Glazed Panels Please Specify:

- Fabric color
- Wood stain color
- Glazing color
- Raceway color

Sample Code

7	PBG6	42	36	H
Product Family	Product Code	Height	Width	Product Modifier

Panelink Glazed Panels

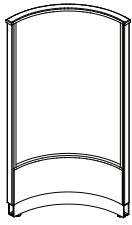

PRG1

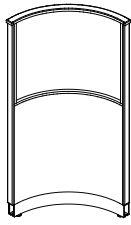

PRG2

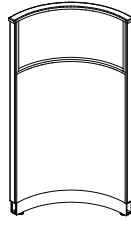

PRG3

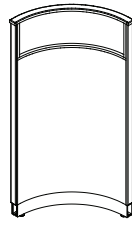

PRG4

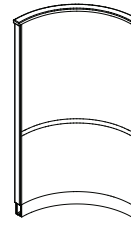

PRG5

(G1 Radius Glazed Panel) (G2 Radius Glazed Panel) (G3 Radius Glazed Panel) (G4 Radius Glazed Panel) (G5 Radius Glazed Panel)

Radiused Glazed Panels, Non Hang-on	Fabric Options	Gr. 1 Fabric	Width Weight (inches) (lbs.)	
	7-PRG1-5424-N	1280	24	33
	7-PRG1-6024-N	1314	24	35
	7-PRG1-6624-N	1349	24	37
	7-PRG1-7224-N	1399	24	39
	7-PRG1-8424-N	1586	24	43
	7-PRG2-5424-N	1280	24	40
	7-PRG2-6024-N	1314	24	42
	7-PRG2-6624-N	1349	24	44
	7-PRG2-7224-N	1399	24	46
	7-PRG2-8424-N	1586	24	50
	7-PRG3-5424-N	1280	24	39
	7-PRG3-6624-N	1349	24	44
	7-PRG3-7224-N	1399	24	47
	7-PRG3-8424-N	1586	24	52
	7-PRG4-6024-N	1314	24	42
	7-PRG4-6624-N	1349	24	45
	7-PRG4-7224-N	1399	24	47
	7-PRG4-8424-N	1586	24	50
	7-PRG5-5424-N	1280	24	39
	7-PRG5-6024-N	1314	24	41
	7-PRG5-6624-N	1349	24	44
	7-PRG5-7224-N	1399	24	46
	7-PRG5-8424-N	1586	24	50

Glazed Panels

Glazed Panels, Non Hang-on:

Glazed panel
Includes PVC raceway
Includes panel connectors
Electrics sold separately
Frosted glazing available

Upgrades:
Fabric Grade 2 Upgrade: \$43.00/panel
Maple Top Cap Upgrade: \$43.00/panel
Glazed Panel Upgrades:
Frosted or Clear: \$54.00/panel

When Ordering Glazed Panels Please Specify:

Fabric color
Wood stain color
Glazing color
Raceway color

Sample Code

7	PRG4	66	24	N
Product Family	Product Code	Height	Width	Product Modifier

Panelink Glazed Panels

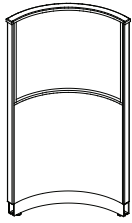

PRG2
(G2 Radius Glazed Panel)

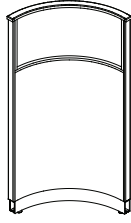

PRG3
(G3 Radius Glazed Panel)

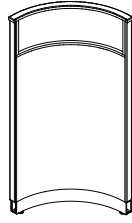

PRG4
(G4 Radius Glazed Panel)

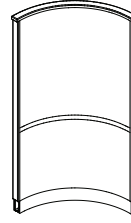

PRG5
(G5 Radius Glazed Panel)

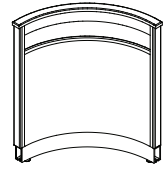

PRG6
(G6 Radius Glazed Panel)

Radiused Glazed Panels, Hang-on

Fabric Options	Gr. 1 Fabric	Width (inches)	Weight (lbs.)
7-PRG2-5424-H	1360	24	44
7-PRG2-6024-H	1393	24	46
7-PRG2-6624-H	1428	24	48
7-PRG2-7224-H	1479	24	50
7-PRG2-8424-H	1665	24	55
7-PRG3-5424-H	1360	24	43
7-PRG3-6624-H	1428	24	49
7-PRG3-7224-H	1479	24	52
7-PRG3-8424-H	1665	24	58
7-PRG4-6024-H	1393	24	47
7-PRG4-6624-H	1428	24	50
7-PRG4-7224-H	1479	24	53
7-PRG4-8424-H	1665	24	59
7-PRG5-5424-H	1360	24	42
7-PRG5-6024-H	1393	24	44
7-PRG5-6624-H	1428	24	46
7-PRG5-7224-H	1479	24	48
7-PRG5-8424-H	1665	24	53
7-PRG6-4224-H	1360	24	45
7-PRG6-4248-H	1510	48	45
7-PRG6-4260-H	1523	60	45

Glazed Panels

Glazed Panels, Hang-on:

Glazed panel
Hang-on capabilities
Includes PVC raceway
Includes panel connectors
Electrics sold separately

Upgrades:

Fabric Grade 2 Upgrade: \$43.00/panel
Maple Top Cap Upgrade: \$43.00/panel

Glazed Panel Upgrades:
Frosted or Clear: \$54.00/panel

When Ordering Glazed Panels Please Specify:

Fabric color
Wood stain color
Glazing color
Raceway color

Sample Code

7	PRG6	66	24	H
Product Family	Product Code	Height	Width	Product Modifier

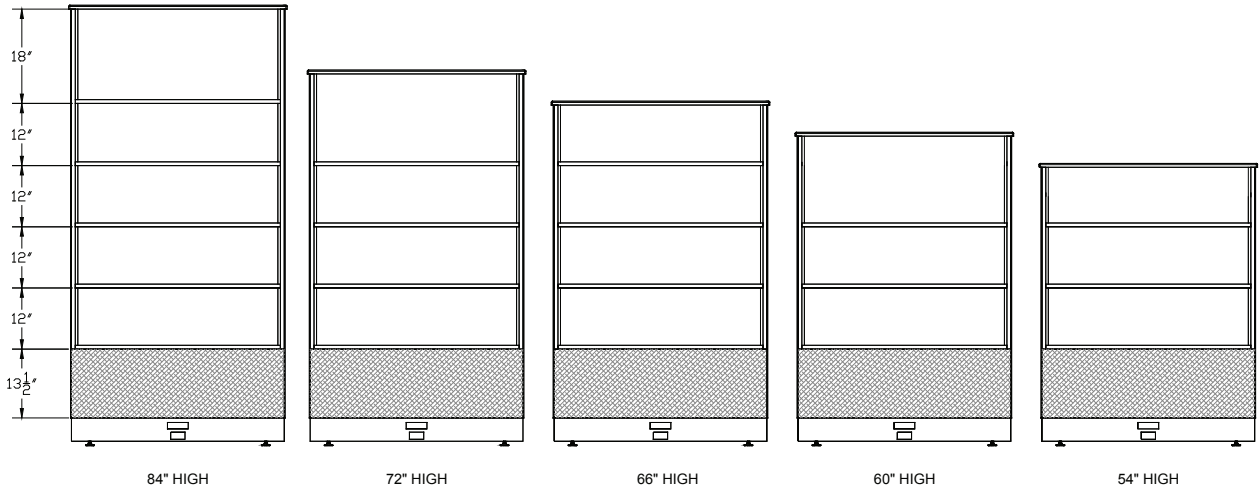

S1 Strata Panels

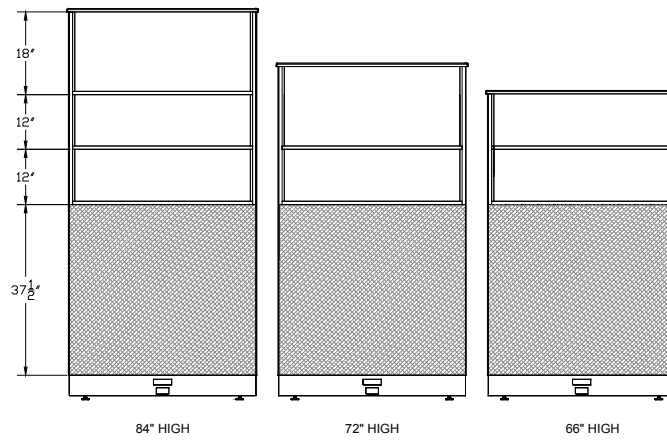

S2 Strata Panels

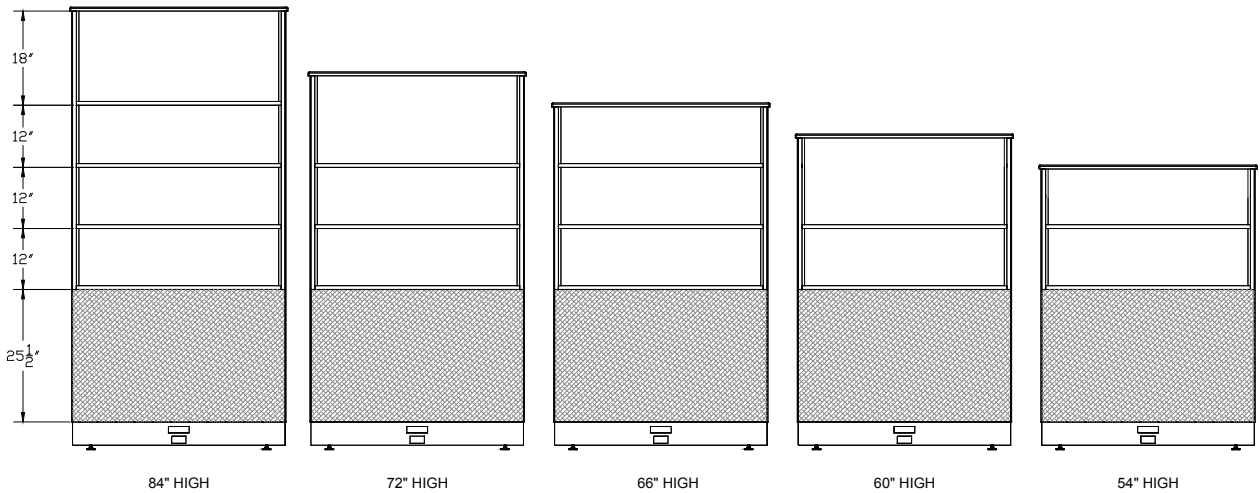

S5 Strata Panels

Strata Panels

Panelink Strata Panels

S1 Strata Panels, Non Hang-on 54" - 84" High

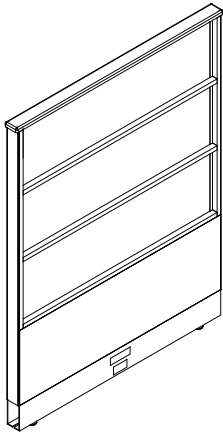

Fabric Options	Gr. 1 Fabric
7-PBS1-5418-N	703
7-PBS1-5424-N	782
7-PBS1-5430-N	834
7-PBS1-5436-N	910
7-PBS1-5442-N	975
7-PBS1-5448-N	1061
7-PBS1-5454-N	1086
7-PBS1-5460-N	1140
7-PBS1-6018-N	777
7-PBS1-6024-N	865
7-PBS1-6030-N	938
7-PBS1-6036-N	1008
7-PBS1-6042-N	1088
7-PBS1-6048-N	1157
7-PBS1-6054-N	1177
7-PBS1-6060-N	1205
7-PBS1-6618-N	808
7-PBS1-6624-N	897
7-PBS1-6630-N	964
7-PBS1-6636-N	1033
7-PBS1-6642-N	1128
7-PBS1-6648-N	1204
7-PBS1-6654-N	1229
7-PBS1-6660-N	1521
7-PBS1-7218-N	829
7-PBS1-7224-N	921
7-PBS1-7230-N	967
7-PBS1-7236-N	1050
7-PBS1-7242-N	1157
7-PBS1-7248-N	1213
7-PBS1-7254-N	1231
7-PBS1-7260-N	1250
7-PBS1-8418-N	846
7-PBS1-8424-N	941
7-PBS1-8430-N	975
7-PBS1-8436-N	1083
7-PBS1-8442-N	1177
7-PBS1-8448-N	1237
7-PBS1-8454-N	1264
7-PBS1-8460-N	1289

Width (inches) Weight (lbs.)

18	19
24	23
30	28
36	32
42	37
48	42
54	46
60	51
18	20
24	25
30	30
36	34
42	39
48	44
54	49
60	54
18	23
24	28
30	33
36	38
42	44
48	49
54	54
60	60
18	24
24	30
36	35
36	40
42	46
48	51
54	57
60	62
18	28
24	34
30	40
36	46
42	53
48	59
54	65
60	71

Strata Panels

Strata Panels, Non Hang-on:

- Strata panel
- No hang-on capabilities
- Includes PVC raceway
- Includes panel connectors
- Electrics sold separately
- Frosted glazing available

Upgrades:

Fabric Grade 2 Upgrade: \$43.00/panel
Maple Top Cap Upgrade: \$43.00/panel

Glazed Panel Upgrades:
Frosted or Clear: \$54.00/panel

When Ordering Strata Panels Please Specify:

- Fabric color
- Wood stain color
- Glazing color
- Raceway color

Sample Code

7	PBS1	42	36	N
Product Family	Product Code	Height	Width	Product Modifier

Panelink Strata Panels

S2 Strata Panels, Non Hang-on 66" - 84" High

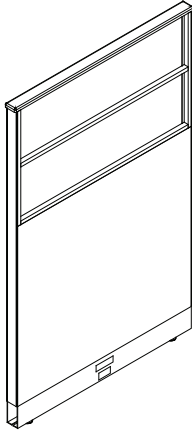

Fabric Options	Gr. 1 Fabric	Width Weight	
		(inches)	(lbs.)
7-PBS2-6618-N	808	18	23
7-PBS2-6624-N	859	24	29
7-PBS2-6630-N	924	30	50
7-PBS2-6636-N	989	36	40
7-PBS2-6642-N	1080	42	46
7-PBS2-6648-N	1152	48	52
7-PBS2-6654-N	1178	54	58
7-PBS2-6660-N	1199	60	63
7-PBS2-7218-N	829	18	25
7-PBS2-7224-N	883	24	31
7-PBS2-7230-N	928	30	37
7-PBS2-7236-N	1005	36	42
7-PBS2-7242-N	1110	42	48
7-PBS2-7248-N	1163	48	54
7-PBS2-7254-N	1191	54	60
7-PBS2-7260-N	1210	60	66
7-PBS2-8418-N	847	18	29
7-PBS2-8424-N	903	24	35
7-PBS2-8430-N	936	30	42
7-PBS2-8436-N	1039	36	48
7-PBS2-8442-N	1128	42	55
7-PBS2-8448-N	1187	48	62
7-PBS2-8454-N	1217	54	68
7-PBS2-8460-N	1233	60	75

Strata Panels

Strata Panels, Non Hang-on:

- Strata panel
- No hang-on capabilities
- Includes PVC raceway
- Includes panel connectors
- Electrics sold separately
- Frosted glazing available

Upgrades:

- Fabric Grade 2 Upgrade: \$43.00/panel
- Maple Top Cap Upgrade: \$43.00/panel

- Glazed Panel Upgrades:
- Frosted or Clear: \$54.00/panel

When Ordering Strata Panels Please Specify:

- Fabric color
- Wood stain color
- Glazing color
- Raceway color

Sample Code

7	PBS2	66	36	N
Product Family	Product Code	Height	Width	Product Modifier

Panelink Strata Panels

S2 Strata Panels, Hang-on 66" - 84" High

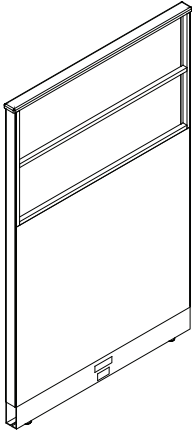

Fabric Options	Gr. 1 Fabric
7-PBS2-6618-H	945
7-PBS2-6624-H	952
7-PBS2-6630-H	1015
7-PBS2-6636-H	1080
7-PBS2-6642-H	1172
7-PBS2-6648-H	1244
7-PBS2-6654-H	1284
7-PBS2-6660-H	1293
<hr/>	
7-PBS2-7218-H	918
7-PBS2-7224-H	977
7-PBS2-7230-H	1022
7-PBS2-7236-H	1097
7-PBS2-7242-H	1203
7-PBS2-7248-H	1255
7-PBS2-7254-H	1289
7-PBS2-7260-H	1300
<hr/>	
7-PBS2-8418-H	931
7-PBS2-8424-H	991
7-PBS2-8430-H	1027
7-PBS2-8436-H	1131
7-PBS2-8442-H	1218
7-PBS2-8448-H	1277
7-PBS2-8454-H	1317
7-PBS2-8460-H	1325

Width (inches)	Weight (lbs.)
----------------	---------------

18	27
24	33
30	35
36	45
42	50
48	56
54	62
60	68
<hr/>	
18	29
24	35
30	41
36	47
42	53
48	58
54	64
60	70
<hr/>	
18	33
24	39
30	46
36	53
42	59
48	66
54	72
60	79

Strata Panels

Strata Panels, Hang-on:

- Strata panel
- Hang-on capabilities
- Includes PVC raceway
- Includes panel connectors
- Electrics sold separately
- Frosted glazing available

Upgrades:

- Fabric Grade 2 Upgrade: \$43.00/panel
- Maple Top Cap Upgrade: \$43.00/panel

- Glazed Panel Upgrades:
- Frosted or Clear: \$54.00/panel

When Ordering Strata Panels Please Specify:

- Fabric color
- Wood stain color
- Glazing color
- Raceway color

Sample Code

7	PBS2	42	36	H
Product Family	Product Code	Height	Width	Product Modifier

Panelink Strata Panels

S5 Strata Panels, Non Hang-on 54" - 84" High

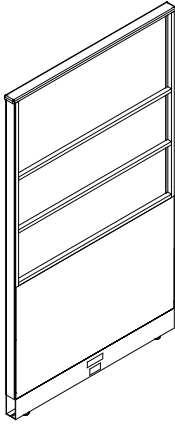

Fabric Options	Gr. 1 Fabric	Width (inches)	Weight (lbs.)
7-PBS5-5418-N	614	18	18
7-PBS5-5424-N	782	24	24
7-PBS5-5430-N	834	30	30
7-PBS5-5436-N	910	36	35
7-PBS5-5442-N	975	42	41
7-PBS5-5448-N	1061	48	47
7-PBS5-5454-N	1086	54	53
7-PBS5-5460-N	1140	60	58
7-PBS5-6018-N	777	18	20
7-PBS5-6024-N	865	24	26
7-PBS5-6030-N	938	30	32
7-PBS5-6036-N	1008	36	37
7-PBS5-6042-N	1088	42	56
7-PBS5-6048-N	1157	48	62
7-PBS5-6054-N	1177	54	55
7-PBS5-6060-N	1205	60	61
7-PBS5-6618-N	808	18	22
7-PBS5-6624-N	897	24	29
7-PBS5-6630-N	964	30	35
7-PBS5-6636-N	1033	36	41
7-PBS5-6642-N	1128	42	48
7-PBS5-6648-N	1204	48	54
7-PBS5-6654-N	1229	54	74
7-PBS5-6660-N	1255	60	67
7-PBS5-7218-N	829	18	24
7-PBS5-7224-N	921	24	30
7-PBS5-7230-N	967	30	37
7-PBS5-7236-N	1050	36	43
7-PBS5-7242-N	1157	42	50
7-PBS5-7248-N	1213	48	57
7-PBS5-7254-N	1242	54	63
7-PBS5-7260-N	1269	60	70
7-PBS5-8418-N	846	18	28
7-PBS5-8424-N	941	24	35
7-PBS5-8430-N	975	30	42
7-PBS5-8436-N	1083	36	49
7-PBS5-8442-N	1177	42	57
7-PBS5-8448-N	1237	48	64
7-PBS5-8454-N	1264	54	71
7-PBS5-8460-N	1289	60	79

Strata Panels

Strata Panels, Non Hang-on:

- Strata panel
- No hang-on capabilities
- Includes PVC raceway
- Includes panel connectors
- Electrics sold separately
- Frosted glazing available

Upgrades:

- Fabric Grade 2 Upgrade: \$43.00/panel
- Maple Top Cap Upgrade: \$43.00/panel

- Glazed Panel Upgrades:
- Frosted or Clear: \$54.00/panel

When Ordering Strata Panels Please Specify:

- Fabric color
- Wood stain color
- Glazing color
- Raceway color

Sample Code

7	PBS5	66	36	N
Product Family	Product Code	Height	Width	Product Modifier

Panelink Strata Panels

S5 Strata Panels, Hang-on 54" - 84" High

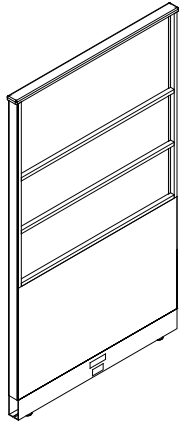

Fabric Options	Gr. 1 Fabric	Width (inches)	Weight (lbs.)
7-PBS5-5418-H	834	18	21
7-PBS5-5424-H	877	24	27
7-PBS5-5430-H	943	30	33
7-PBS5-5436-H	1008	36	38
7-PBS5-5442-H	1071	42	44
7-PBS5-5448-H	1156	48	50
7-PBS5-5454-H	1189	54	56
7-PBS5-5460-H	1226	60	61
7-PBS5-6018-H	914	18	23
7-PBS5-6024-H	963	24	29
7-PBS5-6030-H	1034	30	35
7-PBS5-6036-H	1103	36	40
7-PBS5-6042-H	1182	42	43
7-PBS5-6048-H	1254	48	49
7-PBS5-6054-H	1293	54	58
7-PBS5-6060-H	1331	60	64
7-PBS5-6618-H	966	18	25
7-PBS5-6624-H	1017	24	32
7-PBS5-6630-H	1066	30	38
7-PBS5-6636-H	1146	36	44
7-PBS5-6642-H	1254	42	51
7-PBS5-6648-H	1310	48	57
7-PBS5-6654-H	1349	54	64
7-PBS5-6660-H	1391	60	70
7-PBS5-7218-H	966	18	27
7-PBS5-7224-H	1017	24	33
7-PBS5-7230-H	1066	30	40
7-PBS5-7236-H	1146	36	46
7-PBS5-7242-H	1254	42	53
7-PBS5-7248-H	1310	48	60
7-PBS5-7254-H	1349	54	66
7-PBS5-7260-H	1391	60	73
7-PBS5-8418-H	983	18	31
7-PBS5-8424-H	1035	24	38
7-PBS5-8430-H	1072	30	45
7-PBS5-8436-H	1180	36	52
7-PBS5-8442-H	1271	42	60
7-PBS5-8448-H	1334	48	67
7-PBS5-8454-H	1376	54	74
7-PBS5-8460-H	1417	60	82

Strata Panels

Strata Panels, Hang-on:

- Strata panel
- Hang-on capabilities
- Includes PVC raceway
- Includes panel connectors
- Electrics sold separately
- Frosted glazing available I

Upgrades:

- Fabric Grade 2 Upgrade: \$43.00/panel
- Maple Top Cap Upgrade: \$43.00/panel

- Glazed Panel Upgrades:
- Frosted or Clear: \$54.00/panel

When Ordering Strata Panels Please Specify:

- Fabric color
- Wood stain color
- Glazing color
- Raceway color

Sample Code

7	PBS5	42	36	H
Product Family	Product Code	Height	Width	Product Modifier

Panelink Radius Strata Panels

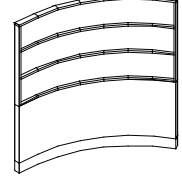
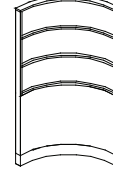
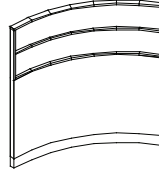
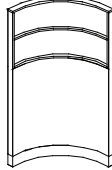
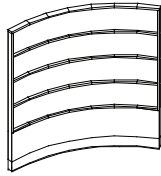
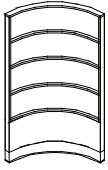

7-PRS1-6624-N
(S1 Radius Strata Panel)

7-PRS1-6660-N
(S1 Radius Strata Panel)

7-PRS2-6624-N
(S2 Radius Strata Panel)

7-PRS2-6660-N
(S2 Radius Strata Panel)

7-PRS5-6624-N
(S5 Radius Strata Panel)

7-PRS5-6660-N
(S5 Radius Strata Panel)

Radius Strata Panels, Non Hang-on	Fabric Options	Gr. 1 Fabric	Width	Weight
			(inches)	(lbs.)
	7-PRS1-5424-N	1440	24	37
	7-PRS1-5448-N	1915	48	59
	7-PRS1-5460-N	2177	60	51
	7-PRS1-6024-N	1482	24	39
	7-PRS1-6048-N	2046	24	62
	7-PRS1-6060-N	2308	60	54
	7-PRS1-6624-N	1525	24	44
	7-PRS1-6648-N	2177	48	68
	7-PRS1-6660-N	2440	60	60
	7-PRS1-7224-N	1584	24	46
	7-PRS1-7248-N	2308	48	70
	7-PRS1-7260-N	2570	60	62
	7-PRS1-8424-N	1809	24	53
	7-PRS1-8448-N	2440	48	79
	7-PRS1-8460-N	2701	60	71
	7-PRS2-6624-N	1480	24	46
	7-PRS2-6648-N	2244	48	68
	7-PRS2-6660-N	2505	60	63
	7-PRS2-7224-N	1538	24	48
	7-PRS2-7248-N	2373	48	70
	7-PRS2-7260-N	2635	60	66
	7-PRS2-8424-N	1752	24	55
	7-PRS2-8448-N	2505	48	79
	7-PRS2-8460-N	2767	60	75
	7-PRS5-5424-N	1440	24	41
	7-PRS5-5448-N	1915	48	56
	7-PRS5-5460-N	2177	60	58
	7-PRS5-6024-N	1482	24	43
	7-PRS5-6048-N	2046	48	62
	7-PRS5-6060-N	2308	60	61
	7-PRS5-6624-N	1525	24	48
	7-PRS5-6648-N	2177	48	68
	7-PRS5-6660-N	2440	60	67
	7-PRS5-7224-N	1584	24	50
	7-PRS5-7248-N	2308	48	70
	7-PRS5-7260-N	2570	60	70
	7-PRS5-8424-N	1809	24	57
	7-PRS5-8448-N	2440	48	79
	7-PRS5-8460-N	2701	60	79

Radius Strata Panels

Radiused Strata Panels, Non Hang-on:

- Glazed panel
- No hang-on capabilities
- Includes PVC raceway
- Includes panel connectors
- Electrics sold separately
- Cannot be powered - pass through electrics only
- Frosted glazing available

When Ordering Radiused Strata Panels Please Specify:

- Fabric color
- Wood stain color
- Glazing color
- Raceway color

Upgrades:

Fabric Grade 2 Upgrade: \$43.00/panel
 Maple Top Cap Upgrade: \$43.00/panel

Glazed Panel Upgrades:
 Frosted or Clear: \$54.00/panel

Sample Code

7	PRS5	66	24	N
Product Family	Product Code	Height	Width	Product Modifier

Panelink Radius Strata Panels

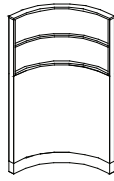

7-PRS2-6624-H
(S2 Radius Strata Panel)

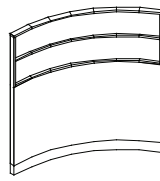

7-PRS2-6660-H
(S2 Radius Strata Panel)

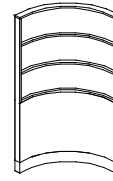

7-PRS5-6624-H
(S5 Radius Strata Panel)

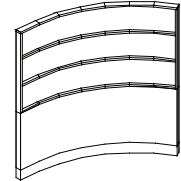

7-PRS5-6660-H
(S5 Radius Strata Panel)

Radiused Strata Panels, Hang-on

Fabric Options	Gr. 1 Fabric	Width Weight	
		(inches)	(lbs.)
7-PRS2-6624-H	1572	24	50
7-PRS2-6648-H	2373	48	68
7-PRS2-6660-H	2635	60	68
7-PRS2-7224-H	1630	24	53
7-PRS2-7248-H	2505	48	70
7-PRS2-7260-H	2767	60	70
7-PRS2-8424-H	1844	24	59
7-PRS2-8448-H	2635	48	79
7-PRS2-8460-H	2897	60	79
7-PRS5-5424-H	1538	24	44
7-PRS5-5448-H	2046	48	62
7-PRS5-5460-H	2308	60	61
7-PRS5-6024-H	1577	24	46
7-PRS5-6048-H	2177	48	65
7-PRS5-6060-H	2440	60	64
7-PRS5-6624-H	1622	24	51
7-PRS5-6648-H	2308	48	71
7-PRS5-6660-H	2570	60	70
7-PRS5-7224-H	1680	24	53
7-PRS5-7248-H	2440	48	73
7-PRS5-7260-H	2701	60	73
7-PRS5-8424-H	1903	24	60
7-PRS5-8448-H	2570	48	82
7-PRS5-8460-H	2832	60	82

Radius Strata Panels

Radiused Strata Panels, Hang-on:

- Strata panel
- Hang-on capabilities
- Includes PVC raceway
- Includes panel connectors
- Electrics sold separately
- Cannot be powered - pass through electrics only
- Frosted glazing available

Upgrades:

- Fabric Grade 2 Upgrade: \$43.00/panel
- Maple Top Cap Upgrade: \$43.00/panel

- Glazed Panel Upgrades:
- Frosted or Clear: \$54.00/panel

When Ordering Radiused Strata Panels Please Specify:

- Fabric color
- Wood stain color
- Glazing color
- Raceway color

Sample Code

7	PRS5	66	24	H
Product Family	Product Code	Height	Width	Product Modifier

Panelink Panel Doors

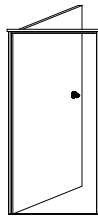

PD00
(Panel Door)

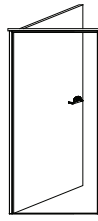

PD01
(Panel Door with Lever Handle)

Panel Doors

Item Number	List	Weight (lbs.)
7-PD00-8436-L	1289	53
7-PD00-8436-R	1289	53
7-PD00-8442-L	1801	66
7-PD00-8442-R	1801	66
7-PD01-8436-L	1486	53
7-PD01-8436-R	1486	53
7-PD01-8442-L	1999	66
7-PD01-8442-R	1999	66

Panel Doors:

- Includes panel connectors
- Two sizes available
- 42" wide door panel permits wheelchair accessibility
- Lever handle complies with handicap codes
- Lock standard on both handle options

When Ordering Panel Doors Please Specify:

- Door panel color
- Left or right swing
- Panel trim color

Sample Code

7	PD00	84	42	L
Product Family	Product Code	Height	Width	Product Modifier

To properly finish every panel configuration, panel fillers and connectors are required.

End Posts

End posts are required at the end of a run of panels. End posts cover the gap created by the electrical raceway and give the panel an elegant finished look. End Posts are available in stained wood and metal. End posts are also available in variable heights.

90° Fillers

90° fillers are used to fill a 90° bend in a run of panels. 90° fillers are available in partial and full lengths. Full length 90° fillers integrate with Panelink 7 electrical raceways. All 90° fillers are fabric wrapped.

“T” Fillers

“T” fillers are needed to fill a gap created during 3 panel connection. “T” fillers are available in partial and full lengths. Full length “T” fillers offer a matching base to integrate with Panelink 7 electrical raceways. All “T” fillers are fabric wrapped.

135° Fillers

135° fillers are used to fill a gap created by a 135° bend in the panel run. 135° fillers are available in partial and full lengths. Full length 135° fillers integrate with Panelink 7 electrical raceways. All 135° fillers are fabric wrapped.

Wall To Panel Connectors

Wall to panel connectors are used to connect runs of panels to walls. Tayco offers various wall to panel connectors. Please consult Tayco Customer Service to find out what method is right for your project.

Panelink Panel Fillers



7-HET0-24
(End Post)



7-HFNP-24
(90° Filler)



7-HFNR-66
(90° Filler with Raceway)



7-HFTP-36
(\"T\" Filler)

Panel Fillers

Item Number	List Price	Height (inches)	Weight (lbs.)
7-HET0-06	26	6	0.2
7-HET0-12	26	12	0.3
7-HET0-18	27	18	0.5
7-HET0-24	29	24	0.7
7-HET0-30	29	30	0.8
7-HET0-36	31	36	1.0
7-HET0-42	33	42	1.1
7-HET0-48	37	48	1.3
7-HET0-54	43	54	1.5
7-HET0-60	48	60	1.6
7-HET0-66	56	66	1.8
7-HET0-72	59	72	2.0
7-HET0-84	67	84	2.3
<hr/>			
7-HFNP-06	40	6	0.2
7-HFNP-12	42	12	0.3
7-HFNP-18	43	18	0.5
7-HFNP-24	46	24	0.6
7-HFNP-30	52	30	0.8
7-HFNP-36	59	36	0.9
7-HFNP-42	63	42	1.1
7-HFNP-48	70	48	1.2
7-HFNP-54	72	54	1.4
<hr/>			
7-HFNR-30	52	30	0.8
7-HFNR-36	59	36	0.9
7-HFNR-42	63	42	1.1
7-HFNR-48	70	48	1.2
7-HFNR-54	72	54	1.4
7-HFNR-60	76	60	1.5
7-HFNR-66	89	66	1.7
7-HFNR-72	92	72	1.8
7-HFNR-84	100	84	2.1
<hr/>			
7-HFTP-06	39	6	0.1
7-HFTP-12	40	12	0.2
7-HFTP-18	42	18	0.3
7-HFTP-24	45	24	0.4
7-HFTP-30	46	30	0.5
7-HFTP-36	50	36	0.6
7-HFTP-42	57	42	0.7
7-HFTP-48	60	48	0.7
7-HFTP-54	63	54	0.9

Panel Fillers:
 Fabric wrapped
 Durable PVC construction
 Designed to give a clean finished look to an installation

When Ordering Panel Fillers Please Specify:

Fabric color
 Wood color (Top Caps sold separately)
 Raceway color

Sample Code

7	HETO	66
Product Family	Product Code	Height

Panelink Panel Fillers



7-HFTR-30
("T" Filler with Raceway)



7-HF1R-42
(135° Filler with Raceway)

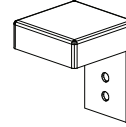

7-HUFC
(Universal Top Cap Filler)

Panel Fillers

Item Number	List Price	Height (inches)	Weight (lbs.)
7-HFTR-30	46	30	0.5
7-HFTR-36	50	36	0.6
7-HFTR-42	57	42	0.7
7-HFTR-48	60	48	0.8
7-HFTR-54	63	54	0.9
7-HFTR-60	70	60	1.0
7-HFTR-66	76	66	1.1
7-HFTR-72	86	72	1.2
7-HFTR-84	92	84	1.4
7-HF1R-30	57	30	0.6
7-HF1R-36	59	36	0.7
7-HF1R-42	61	42	0.8
7-HF1R-48	65	48	0.8
7-HF1R-54	70	54	0.9
7-HF1R-60	76	60	1.0
7-HF1R-66	86	66	1.1
7-HF1R-72	92	72	1.2
7-HF1R-84	100	84	1.3
7-HUFC-02	29		0.2

Panel Fillers

Panel Fillers:
 Fabric wrapped
 Durable PVC construction
 Designed to give a clean finished look to an installation

When Ordering Panel Fillers Please Specify:
 Fabric color
 Wood color (Top Caps sold separately)
 Raceway color

Sample Code

7	HFTR	66
Product Family	Product Code	Height

Panelink Panel Fillers



7-HWF1-30
(Wall to Panel Connector
Fixed)



7-HWA1-30
(Type 1 Adjustable
0" to 3")



7-HWA2-48
(Type 2 Adjustable
3" to 6")

Wall to Panel Connectors

Item Number	List Price	Height (inches)	Weight (lbs.)
7-HWF1-30	61	30	1.4
7-HWF1-36	70	36	1.7
7-HWF1-42	79	42	2.1
7-HWF1-48	88	48	2.4
7-HWF1-54	100	54	2.7
7-HWF1-60	112	60	3.1
7-HWF1-66	124	66	3.4
7-HWF1-72	136	72	3.7
7-HWF1-84	162	84	4.4
7-HWA1-30	197	30	6.5
7-HWA1-36	203	36	7.9
7-HWA1-42	210	42	9.2
7-HWA1-48	215	48	10
7-HWA1-54	224	54	11
7-HWA1-60	229	60	13
7-HWA1-66	235	66	14
7-HWA1-72	242	72	15
7-HWA1-84	248	84	18
7-HWA2-30	224	30	9.5
7-HWA2-36	229	36	11
7-HWA2-42	235	42	13
7-HWA2-48	242	48	12
7-HWA2-54	248	54	17
7-HWA2-60	256	60	19
7-HWA2-66	262	66	20
7-HWA2-72	269	72	22
7-HWA2-84	275	84	26

Panel Fillers

Panel Fillers:

Fabric wrapped
Durable PVC construction
Designed to give a clean finished look to an installation
Please note there will be a gap between bottom of product and the floor for baseboards

When Ordering Panel Fillers Please Specify:

Fabric color
Wood color (Top Caps sold separately)
Raceway color

Sample Code

7	HWA3	66
Product Family	Product Code	Height

Panelink Panel Accessories

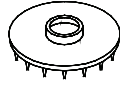

7-HGC0
(Carpet Gripper)



7-HGN0
(Tile Gripper)

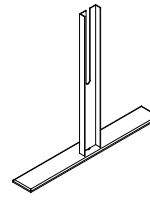

7-HPSF-16
(Stabilizing Foot)

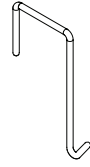

7-ACH0
(Coat Hook)

Panel Accessories

Item Number	List Price	Weight (lbs.)
7-HGC0	4	0.0
7-HGN0	4	0.0
7-HPSF-16	50	3.2
7-ACH0	50	0.1

Panel Accessories

Sample Code

7	HWA3	66
Product Family	Product Code	Height

Panelink Counter Tops

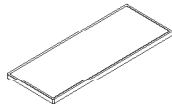

7-WTSS-6014
(Straight Counter Top)

Straight Counter Tops	Item Number	List Price	Width (inches)	Depth (inches)	Weight (lbs.)
	7-WTSS-1814	79	18	24	6
	7-WTSS-2414	88	24	14	9
	7-WTSS-2614	91	26	14	9
	7-WTSS-3014	93	30	14	11
	7-WTSS-3214	95	32	14	12
	7-WTSS-3614	98	36	14	13
	7-WTSS-3814	102	38	14	14
	7-WTSS-4214	106	42	14	15
	7-WTSS-4414	108	44	14	16
	7-WTSS-4814	110	48	14	17
	7-WTSS-5014	112	50	14	18
	7-WTSS-5414	118	54	14	19
	7-WTSS-5614	120	56	14	20
	7-WTSS-6014	126	60	14	22
	7-WTSS-6214	128	62	14	22
	7-WTSS-6614	136	66	14	24
	7-WTSS-6814	139	68	14	24
	7-WTSS-7214	146	72	14	26
	7-WTSS-7414	148	74	14	27
	7-WTSS-7814	154	78	14	28
	7-WTSS-8014	156	80	14	29
	7-WTSS-8414	165	84	14	30
	7-WTSS-8614	167	86	14	31
	7-WTSS-9014	173	90	14	32
	7-WTSS-9214	175	92	14	33
	7-WTSS-9614	182	96	14	35

Counter Tops

Straight Counter Tops:
 Custom sizes available
 Support hardware included

When Ordering Straight Counter Tops Please Specify:

Surface color
 Surface trim color

Sample Code

7	WTSS	96	14	W
Product Family	Product Code	Width	Depth	Product Modifier

Panelink Counter Tops

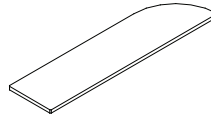
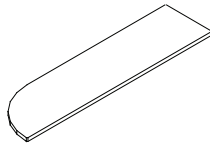

7-WTSR-6214-L
(Straight Radiused
Counter Top)

7-WTSR-6214-R
(Straight Radiused
Counter Top)

Straight Radiused Counter Tops

Item Number	List Price	Width (inches)	Depth (inches)	Weight (lbs.)
7-WTSR-2614-L	94	26	14	8
7-WTSR-3214-L	106	32	14	10
7-WTSR-3814-L	111	38	14	13
7-WTSR-4414-L	119	44	14	15
7-WTSR-5014-L	126	50	14	17
7-WTSR-5614-L	132	56	14	19
7-WTSR-6214-L	142	62	14	21
7-WTSR-6814-L	151	68	14	23
7-WTSR-7414-L	165	74	14	26
7-WTSR-8014-L	174	80	14	28
7-WTSR-8614-L	187	86	14	30
7-WTSR-9214-L	199	92	14	32
7-WTSR-2614-R	94	26	14	8
7-WTSR-3214-R	106	32	14	10
7-WTSR-3814-R	111	38	14	13
7-WTSR-4414-R	119	44	14	15
7-WTSR-5014-R	126	50	14	17
7-WTSR-5614-R	132	56	14	19
7-WTSR-6214-R	142	62	14	21
7-WTSR-6814-R	151	68	14	23
7-WTSR-7414-R	165	74	14	26
7-WTSR-8014-R	174	80	14	28
7-WTSR-8614-R	187	86	14	30
7-WTSR-9214-R	199	92	14	32

Counter Tops

Straight Radiused Counter Tops:

Custom sizes available
Support hardware included

Sample Code

7	WTSR	68	14	W
Product Family	Product Code	Width	Depth	Product Modifier

Panelink Counter Tops

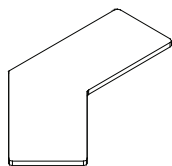

7-WTE2-3314
(Type 2 Elbow)

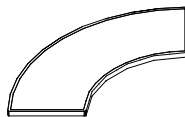

7-WTRP-2414
(Radiused Panel Counter)



7-WTRP-2414
(Radiused Panel Counter
with Wood Trim)

Elbow Counter Tops

Item Number	List Price	Width (inches)	Depth (inches)	Weight (lbs.)
7-WTE2-2714	322	27	14	25
7-WTE2-3314	385	33	14	34
7-WTRP-2414	270	24	14	8

Counter Tops

Elbow Counter Tops:
Custom sizes available
Support hardware included

When Ordering Elbow Counter Tops Please Specify:

Surface Color
Trim Color

Sample Code

7	WTRP	24	14	W
Product Family	Product Code	Width	Depth	Product Modifier

Panelink Work Surfaces

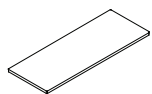

7-WS00-3618
(Straight Work Surface)

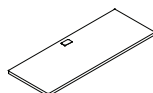

7-WS0G-3618
(Straight Work Surface with Grommets)

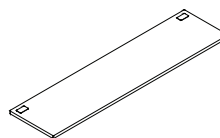

7-WS0G-6618
(Straight Work Surface with Grommets)

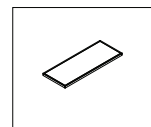

7-WS0G-9618
(Straight Work Surface with Grommets)

18" Straight Surfaces

Item Number	List Price	Width (inches)	Depth (inches)	Weight (lbs.)
7-WS00-1818	128	18	18	8
7-WS00-2418	134	24	18	11
7-WS00-3018	144	30	18	14
7-WS00-3618	152	36	18	17
7-WS00-4218	174	42	18	19
7-WS00-4818	185	48	18	22
7-WS00-5418	204	54	18	25
7-WS00-6018	226	60	18	27
7-WS00-6618	262	66	18	30
7-WS00-7218	278	72	18	33
7-WS00-7818	306	78	18	36
7-WS00-8418	335	84	18	36
7-WS00-9018	367	90	18	41
7-WS00-9618	402	96	18	44
<hr/>				
7-WS0G-1818	148	18	18	8
7-WS0G-2418	153	24	18	11
7-WS0G-3018	165	30	18	14
7-WS0G-3618	171	36	18	17
7-WS0G-4218	194	42	18	19
7-WS0G-4818	204	48	18	22
<hr/>				
7-WS0G-5418	243	54	18	25
7-WS0G-6018	264	60	18	27
7-WS0G-6618	301	66	18	30
7-WS0G-7218	319	72	18	33
7-WS0G-7818	346	78	18	36
7-WS0G-8418	375	84	18	39
<hr/>				
7-WS0G-9018	427	90	18	41
7-WS0G-9618	461	96	18	44

Work Surfaces

Straight Work Surfaces:

- 1" standard thickness
- PVC edging standard
- Grommet included {black grommet standard}

When Ordering Straight Work Surfaces Please Specify:

- Laminate color
- Trim color

Sample Code

7	WS0G	48	18
Product Family	Product Code	Width	Depth

Panelink Work Surfaces

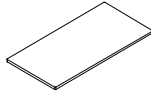

7-WS00-3624
(Straight Work Surface)

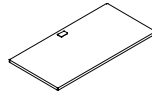

7-WS0G-3624
(Straight Work Surface with Grommets)

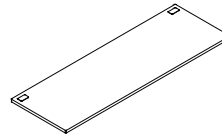

7-WS0G-6624
(Straight Work Surface with Grommets)

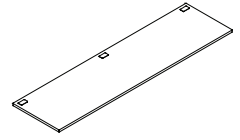

7-WS0G-9624
(Straight Work Surface with Grommets)

24" Straight Surfaces

Item Number	List Price	Width (inches)	Depth (inches)	Weight (lbs.)
7-WS00-1824	134	18	24	11
7-WS00-2424	146	24	24	15
7-WS00-3024	155	30	24	18
7-WS00-3624	162	36	24	22
7-WS00-4224	193	42	24	26
7-WS00-4824	210	48	24	29
7-WS00-5424	235	54	24	33
7-WS00-6024	249	60	24	37
7-WS00-6624	282	66	24	40
7-WS00-7224	296	72	24	44
7-WS00-7824	325	78	24	48
7-WS00-8424	355	84	24	52
7-WS00-9024	391	90	24	55
7-WS00-9624	427	96	24	59
<hr/>				
7-WS0G-1824	153	18	24	11
7-WS0G-2424	166	24	24	15
7-WS0G-3024	175	30	24	18
7-WS0G-3624	181	36	24	22
7-WS0G-4224	212	42	24	26
7-WS0G-4824	229	48	24	29
<hr/>				
7-WS0G-5424	275	54	24	33
7-WS0G-6024	289	60	24	37
7-WS0G-6624	321	66	24	40
7-WS0G-7224	335	72	24	44
7-WS0G-7824	365	78	24	48
7-WS0G-8424	394	84	24	52
<hr/>				
7-WS0G-9024	449	90	24	55
7-WS0G-9624	486	96	24	59

Work Surfaces

Straight Work Surfaces:

- 1" standard thickness
- PVC edging standard
- Grommet included {black grommet standard}

When Ordering Straight Work Surfaces Please Specify:

- Laminate color
- Trim color

Sample Code

7	WS0G	60	24
Product Family	Product Code	Width	Depth

Panelink Work Surfaces

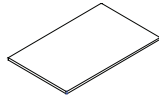

7-WS00-3630
(Straight Work Surface)

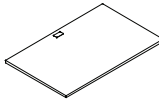

7-WS0G-3630
(Straight Work Surface with Grommets)

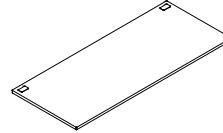

7-WS0G-6630
(Straight Work Surface with Grommets)

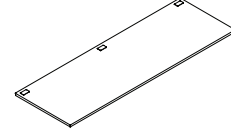

7-WS0G-9630
(Straight Work Surface with Grommets)

30" Straight Surfaces

Item Number	List Price	Width (inches)	Depth (inches)	Weight (lbs.)
7-WS00-1830	144	18	30	14
7-WS00-2430	162	24	30	18
7-WS00-3030	187	30	30	23
7-WS00-3630	201	36	30	28
7-WS00-4230	216	42	30	32
7-WS00-4830	238	48	30	37
7-WS00-5430	248	54	30	41
7-WS00-6030	264	60	30	46
7-WS00-6630	307	66	30	51
7-WS00-7230	318	72	30	55
7-WS00-7830	348	78	30	60
7-WS00-8430	380	84	30	64
7-WS00-9030	417	90	30	69
7-WS00-9630	455	96	30	74
<hr/>				
7-WS0G-1830	165	18	30	14
7-WS0G-2430	181	24	30	18
7-WS0G-3030	207	30	30	23
7-WS0G-3630	219	36	30	28
7-WS0G-4230	238	42	30	32
7-WS0G-4830	258	48	30	37
<hr/>				
7-WS0G-5430	288	54	30	41
7-WS0G-6030	304	60	30	46
7-WS0G-6630	347	66	30	51
7-WS0G-7230	356	72	30	55
7-WS0G-7830	388	78	30	60
7-WS0G-8430	418	84	30	64
<hr/>				
7-WS0G-9030	476	30	30	69
7-WS0G-9630	514	96	30	74

Work Surfaces

Straight Work Surfaces:

1" standard thickness
PVC edging standard
Grommet included {black grommet standard}

When Ordering Straight Work Surfaces Please Specify:

Laminate color
Trim color

Sample Code

7	WS0G	60	30
Product Family	Product Code	Width	Depth

Panelink Work Surfaces

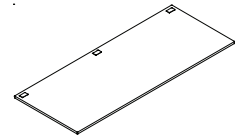
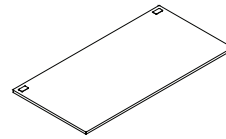
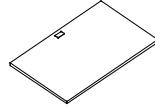
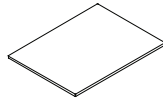

7-WS00-3636
(Straight Work Surface)

7-WS0G-3636
(Straight Work Surface with Grommets)

7-WS0G-6636
(Straight Work Surface with Grommets)

7-WS0G-9636
(Straight Work Surface with Grommets)

36" Straight Surfaces

Item Number	List Price	Width (inches)	Depth (inches)	Weight (lbs.)
7-WS00-1836	152	18	36	17
7-WS00-2436	162	24	36	22
7-WS00-3036	201	30	36	28
7-WS00-3636	210	36	36	33
7-WS00-4236	228	42	36	39
7-WS00-4836	248	48	36	44
7-WS00-5436	261	54	36	50
7-WS00-6036	277	60	36	55
7-WS00-6636	323	66	36	61
7-WS00-7236	333	72	36	66
7-WS00-7836	365	78	36	72
7-WS00-8436	397	84	36	77
7-WS00-9036	439	90	36	83
7-WS00-9636	477	96	36	88
<hr/>				
7-WS0G-1836	171	18	36	17
7-WS0G-2436	200	24	36	22
7-WS0G-3036	219	30	36	28
7-WS0G-3636	229	36	36	33
7-WS0G-4236	247	42	36	39
7-WS0G-4836	269	48	36	44
<hr/>				
7-WS0G-5436	300	54	36	50
7-WS0G-6036	318	60	36	55
7-WS0G-6636	362	66	36	61
7-WS0G-7236	372	72	36	66
7-WS0G-7836	404	78	36	72
7-WS0G-8436	438	84	36	77
<hr/>				
7-WS0G-9036	498	90	36	83
7-WS0G-9636	536	96	36	88

Work Surfaces

Straight Work Surfaces:

- 1" standard thickness
- PVC edging standard
- Grommet included {black grommet standard}

When Ordering Straight Work Surfaces Please Specify:

- Laminate color
- Trim color

Sample Code

7	WS0G	60	36
Product Family	Product Code	Width	Depth

Panelink Work Surfaces

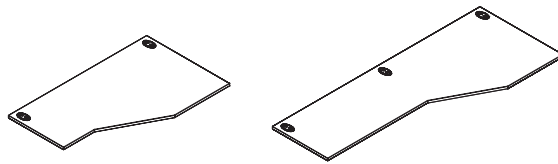

7-WUSG-6036-L
(Unitized Work Surface
Straight Front with Grommets)

7-WUSG-9036-L
(Unitized Work Surface
Straight Front with Grommets)

**Unitized Surfaces
Straight Front
Left Handed**

Item Number	List Price	Width (inches)	Depth (inches)	Weight (lbs.)
7-WUSG-5436-L	474	54	36	44
7-WUSG-6036-L	505	60	36	48
7-WUSG-6636-L	536	66	36	51
7-WUSG-7236-L	563	72	36	55
7-WUSG-7836-L	628	78	36	59
7-WUSG-8436-L	694	84	36	62
7-WUSG-9036-L	845	90	36	66
7-WUSG-9636-L	861	96	36	70

Work Surfaces

Unitized Work Surfaces:

- 1" standard thickness
- PVC edging standard
- Grommet included {black grommet standard}

When Ordering Unitized Work Surfaces Please Specify:

- Laminate color
- Trim color

Sample Code

7	WUSG	60	30	L
Product Family	Product Code	Width	Depth	Product Modifier

Panelink Work Surfaces

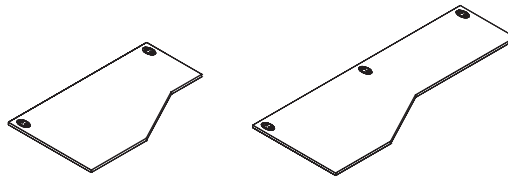

7-WUSG-6036-R
(Unitized Work Surface
Straight Front with Grommets)

7-WUSG-9036-R
(Unitized Work Surface
Straight Front with Grommets)

**Unitized Surfaces
Straight Front
Right Handed**

Item Number	List Price	Width (inches)	Depth (inches)	Weight (lbs.)
7-WUSG-5436-R	474	54	36	44
7-WUSG-6036-R	505	60	36	48
7-WUSG-6636-R	536	66	36	51
7-WUSG-7236-R	563	72	36	55
7-WUSG-7836-R	628	78	36	59
7-WUSG-8436-R	694	84	36	62
7-WUSG-9036-R	845	90	36	66
7-WUSG-9636-R	861	96	36	70

Work Surfaces

Unitized Work Surfaces:

- 1" standard thickness
- PVC edging standard
- Grommet included {black grommet standard}

When Ordering Unitized Work Surfaces Please Specify:

- Laminate color
- Trim color

Sample Code

7	WUSG	60	30	R
Product Family	Product Code	Width	Depth	Product Modifier

Panelink Work Surfaces

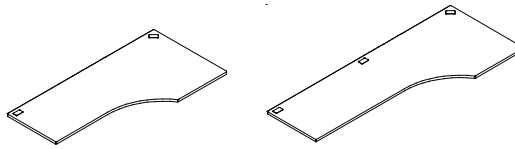

7-WUCG-7236-L
(Unitized Work Surface
Curved Front with Grommets)

7-WUCG-9036-L
(Unitized Work Surface
Curved Front with Grommets)

**Unitized Surfaces
Curved Front
Left Handed**

Item Number	List Price	Width (inches)	Depth (inches)	Weight (lbs.)
7-WUCG-5436-L	539	54	36	41
7-WUCG-6036-L	570	60	36	45
7-WUCG-6636-L	602	66	36	49
7-WUCG-7236-L	628	72	36	52
7-WUCG-7836-L	694	78	36	56
7-WUCG-8436-L	717	84	36	60
7-WUCG-9036-L	910	90	36	63
7-WUCG-9636-L	927	96	36	67

Work Surfaces

Unitized Work Surfaces:

- 1" standard thickness
- PVC edging standard
- Grommet included {black grommet standard}

When Ordering Unitized Work Surfaces Please Specify:

- Laminate color
- Trim color

Sample Code

7	WUCG	60	30	L
Product Family	Product Code	Width	Depth	Product Modifier

Panelink Work Surfaces

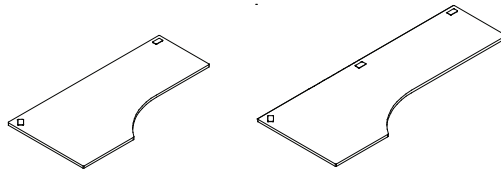

7-WUCG-7236-R
(Unitized Work Surface
Curved Front with Grommets)

7-WUCG-9036-R
(Unitized Work Surface
Curved Front with Grommets)

**Unitized Surfaces
Curved Front
Right Handed**

Item Number	List Price	Width (inches)	Depth (inches)	Weight (lbs.)
7-WUCG-5436-R	539	54	36	41
7-WUCG-6036-R	570	60	36	45
7-WUCG-6636-R	602	66	36	49
7-WUCG-7236-R	628	72	36	52
7-WUCG-7836-R	694	78	36	56
7-WUCG-8436-R	760	84	36	60
7-WUCG-9036-R	910	90	36	63
7-WUCG-9636-R	927	96	36	67

Work Surfaces

Unitized Work Surfaces:

- 1" standard thickness
- PVC edging standard
- Grommet included {black grommet standard}

When Ordering Unitized Work Surfaces Please Specify:

- Laminate color
- Trim color

Sample Code

7	WUCG	60	30	R
Product Family	Product Code	Width	Depth	Product Modifier

Panelink Work Surfaces

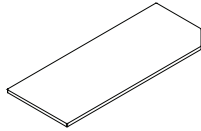

7-WNS0-6024-L
(24" Notched Surface
Left Handed)

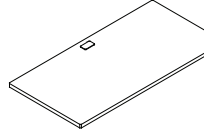

7-WNSG-4824-L
(24" Notched Surface
Left Handed with Grommet)

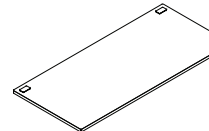

7-WNSG-6624-L
(24" Notched Surface
Left Handed with Grommets)

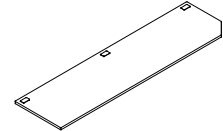

7-WNSG-9624-L
(24" Notched Surface
Left Handed with Grommets)

24" Notched Surface Left Handed

Item Number	List Price	Width (inches)	Depth (inches)	Weight (lbs.)
7-WNS0-1824-L	146	18	24	10
7-WNS0-2424-L	153	24	24	14
7-WNS0-3024-L	162	30	24	18
7-WNS0-3624-L	169	36	24	22
7-WNS0-4224-L	203	42	24	25
7-WNS0-4824-L	219	48	24	29
7-WNS0-5424-L	235	54	24	33
7-WNS0-6024-L	263	60	24	36
7-WNS0-6624-L	300	66	24	40
7-WNS0-7224-L	308	72	24	44
7-WNS0-7824-L	341	78	24	47
7-WNS0-8424-L	372	84	24	51
7-WNS0-9024-L	409	90	24	55
7-WNS0-9624-L	445	96	24	58
<hr/>				
7-WNSG-1824-L	166	18	24	10
7-WNSG-2424-L	173	24	24	14
7-WNSG-3024-L	181	30	24	18
7-WNSG-3624-L	188	36	24	22
7-WNSG-4224-L	224	42	24	25
7-WNSG-4824-L	240	48	24	29
<hr/>				
7-WNSG-5424-L	275	54	24	33
7-WNSG-6024-L	302	60	24	36
7-WNSG-6624-L	338	66	24	40
7-WNSG-7224-L	348	72	24	44
7-WNSG-7824-L	380	78	24	47
7-WNSG-8424-L	412	84	24	51
<hr/>				
7-WNSG-9024-L	468	90	24	55
7-WNSG-9624-L	504	96	24	58

Work Surfaces

24" Notched Surfaces:

- 1" standard thickness
- PVC edging standard
- Grommet included {black grommet standard}

When Ordering 24" Notched Surfaces Please Specify:

- Laminate color
- Trim color

Sample Code

7	WNSG	60	24	L
Product Family	Product Code	Width	Depth	Product Modifier

Panelink Work Surfaces

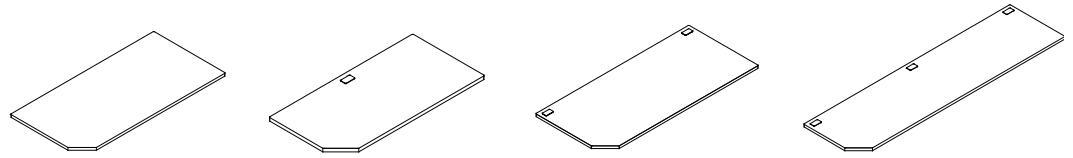

7-WNS0-6024-R
(24" Notched Surface
Right Handed)

7-WNSG-4824-R
(24" Notched Surface
Right Handed with Grommet)

7-WNSG-6624-R
(24" Notched Surface
Right Handed with Grommets)

7-WNSG-9624-R
(24" Notched Surface
Right Handed with Grommets)

24" Notched Surface Right Handed

Item Number	List Price	Length (inches)	Width (inches)	Weight (lbs.)
7-WNS0-1824-R	146	18	24	10
7-WNS0-2424-R	153	24	24	14
7-WNS0-3024-R	162	30	24	18
7-WNS0-3624-R	169	36	24	22
7-WNS0-4224-R	203	42	24	25
7-WNS0-4824-R	219	48	24	29
7-WNS0-5424-R	235	54	24	33
7-WNS0-6024-R	263	60	24	36
7-WNS0-6624-R	300	66	24	40
7-WNS0-7224-R	308	72	24	44
7-WNS0-7824-R	341	78	24	47
7-WNS0-8424-R	372	84	24	51
7-WNS0-9024-R	409	90	24	55
7-WNS0-9624-R	445	96	24	58
<hr/>				
7-WNSG-1824-R	166	18	24	10
7-WNSG-2424-R	173	24	24	14
7-WNSG-3024-R	181	30	24	18
7-WNSG-3624-R	188	36	24	22
7-WNSG-4224-R	224	42	24	25
7-WNSG-4824-R	240	48	24	29
<hr/>				
7-WNSG-5424-R	275	54	24	33
7-WNSG-6024-R	302	60	24	36
7-WNSG-6624-R	338	66	24	40
7-WNSG-7224-R	348	72	24	44
7-WNSG-7824-R	380	78	24	47
7-WNSG-8424-R	412	84	24	51
<hr/>				
7-WNSG-9024-R	468	90	24	55
7-WNSG-9624-R	504	96	24	58

Work Surfaces

24" Notched Surfaces:

- 1" standard thickness
- PVC edging standard
- Grommet included {black grommet standard}

When Ordering 24" Notched Surfaces Please Specify:

- Laminate color
- Trim color

Sample Code

7	WNSG	60	24	R
Product Family	Product Code	Width	Depth	Product Modifier

Panelink Work Surfaces

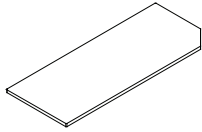

7-WNS0-6030-L
(30" Notched Surface
Left Handed)

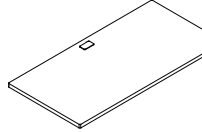

7-WNSG-4830-L
(30" Notched Surface
Left Handed with Grommet)

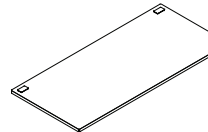

7-WNSG-6630-L
(30" Notched Surface
Left Handed with Grommets)

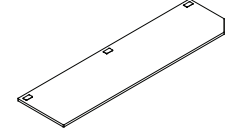

7-WNSG-9630-L
(30" Notched Surface
Left Handed with Grommets)

30" Notched Surface Left Handed

Item Number	List Price	Width (inches)	Depth (inches)	Weight (lbs.)
7-WNS0-1830-L	177	18	30	13
7-WNS0-2430-L	193	24	30	18
7-WNS0-3030-L	201	30	30	23
7-WNS0-3630-L	214	36	30	27
7-WNS0-4230-L	230	42	30	32
7-WNS0-4830-L	249	48	30	36
7-WNS0-5430-L	260	54	30	41
7-WNS0-6030-L	277	60	30	46
7-WNS0-6630-L	321	66	30	50
7-WNS0-7230-L	330	72	30	55
7-WNS0-7830-L	355	78	30	59
7-WNS0-8430-L	384	84	30	64
7-WNS0-9030-L	421	90	30	69
7-WNS0-9630-L	460	96	30	73
<hr/>				
7-WNSG-1830-L	197	18	30	13
7-WNSG-2430-L	212	24	30	18
7-WNSG-3030-L	219	30	30	23
7-WNSG-3630-L	234	36	30	27
7-WNSG-4230-L	249	42	30	32
7-WNSG-4830-L	270	48	30	36
<hr/>				
7-WNSG-5430-L	299	54	30	41
7-WNSG-6030-L	318	60	30	46
7-WNSG-6630-L	360	66	30	50
7-WNSG-7230-L	370	72	30	55
7-WNSG-7830-L	394	78	30	59
7-WNSG-8430-L	424	84	30	64
<hr/>				
7-WNSG-9030-L	479	90	30	69
7-WNSG-9630-L	519	96	30	73

30" Notched Surfaces:

1" standard thickness
PVC edging standard
Grommet included {black grommet standard}

When Ordering 30" Notched Surfaces Please Specify:

Laminate color
Trim color

Sample Code

7	WNSG	60	30	L
Product Family	Product Code	Width	Depth	Product Modifier

Panelink Work Surfaces

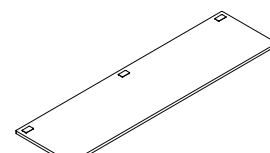
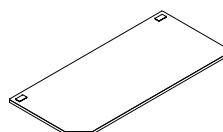
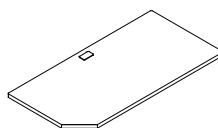
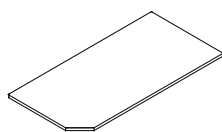

7-WNS0-6030-R
(30" Notched Surface
Right Handed)

7-WNSG-4830-R
(30" Notched Surface
Right Handed with Grommet)

7-WNSG-6630-R
(30" Notched Surface
Right Handed with Grommets)

7-WNSG-9630-R
(30" Notched Surface
Right Handed with Grommets)

30" Notched Surface Right Handed

Item Number	List Price	Width (inches)	Depth (inches)	Weight (lbs.)
7-WNS0-1830-R	177	18	30	13
7-WNS0-2430-R	193	24	30	18
7-WNS0-3030-R	201	30	30	23
7-WNS0-3630-R	214	36	30	27
7-WNS0-4230-R	230	42	30	32
7-WNS0-4830-R	249	48	30	36
7-WNS0-5430-R	260	54	30	41
7-WNS0-6030-R	277	60	30	46
7-WNS0-6630-R	321	66	30	50
7-WNS0-7230-R	330	72	30	55
7-WNS0-7830-R	355	78	30	59
7-WNS0-8430-R	384	84	30	64
7-WNS0-9030-R	421	90	30	69
7-WNS0-9630-R	460	96	30	73
<hr/>				
7-WNSG-1830-R	197	18	30	13
7-WNSG-2430-R	212	24	30	18
7-WNSG-3030-R	219	30	30	23
7-WNSG-3630-R	234	36	30	27
7-WNSG-4230-R	249	42	30	32
7-WNSG-4830-R	377	48	30	36
<hr/>				
7-WNSG-5430-R	299	54	30	41
7-WNSG-6030-R	318	60	30	46
7-WNSG-6630-R	360	66	30	50
7-WNSG-7230-R	370	72	30	55
7-WNSG-7830-R	394	78	30	59
7-WNSG-8430-R	424	84	30	64
<hr/>				
7-WNSG-9030-R	479	90	30	69
7-WNSG-9630-R	519	96	30	73

Work Surfaces

30" Notched Surfaces:

- 1" standard thickness
- PVC edging standard
- Grommet included {black grommet standard}

When Ordering 30" Notched Surfaces Please Specify:

- Laminate color
- Trim color

Sample Code

7	WNSG	60	30	R
Product Family	Product Code	Width	Depth	Product Modifier

Panelink Work Surfaces

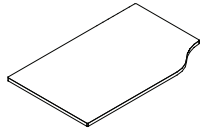

7-WBS0-4824-L
(24" Bowed Surface
Left Handed)

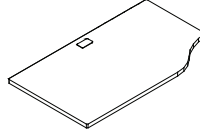

7-WBS0-4824-L
(24" Bowed Surface
Left Handed with Grommet)

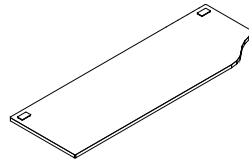

7-WBS0-6624-L
(24" Bowed Surface
Left Handed with Grommets)

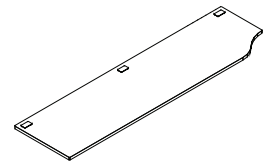

7-WBS0-9624-L
(24" Bowed Surface
Left Handed with Grommets)

24" Bowed Surface Left Handed

Item Number	List Price	Width (inches)	Depth (inches)	Weight (lbs.)
7-WBS0-1824-L	146	18	24	10
7-WBS0-2424-L	153	24	24	14
7-WBS0-3024-L	162	30	24	17
7-WBS0-3624-L	169	36	24	21
7-WBS0-4224-L	203	42	24	25
7-WBS0-4824-L	219	48	24	28
7-WBS0-5424-L	235	54	24	32
7-WBS0-6024-L	263	60	24	36
7-WBS0-6624-L	300	66	24	40
7-WBS0-7224-L	308	72	24	43
7-WBS0-7824-L	341	78	24	47
7-WBS0-8424-L	372	84	24	51
7-WBS0-9024-L	409	90	24	54
7-WBS0-9624-L	445	96	24	58
<hr/>				
7-WBSG-1824-L	166	18	24	10
7-WBSG-2424-L	173	24	24	13
7-WBSG-3024-L	181	30	24	17
7-WBSG-3624-L	188	36	24	21
7-WBSG-4224-L	224	42	24	25
7-WBSG-4824-L	240	48	24	28
<hr/>				
7-WBSG-5424-L	275	54	24	32
7-WBSG-6024-L	302	60	24	36
7-WBSG-6624-L	338	66	24	39
7-WBSG-7224-L	348	72	24	43
7-WBSG-7824-L	380	78	24	47
7-WBSG-8424-L	412	84	24	50
<hr/>				
7-WBSG-9024-L	468	90	24	54
7-WBSG-9624-L	504	96	24	58

Work Surfaces

24" Bowed Surfaces:
1" standard thickness
PVC edging standard

When Ordering 24" Bowed Surfaces Please Specify:

Laminate color
Trim color

Sample Code

7	WBS0	60	24	L
Product Family	Product Code	Length	Depth	Product Modifier

Panelink Work Surfaces

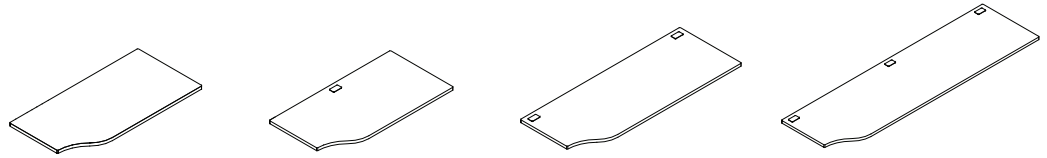

7-WBS0-4824-R
(24" Bowed Surface
Right Handed)

7-WBS0-4824-R
(24" Bowed Surface
Right Handed with Grommet)

7-WBS0-6624-R
(24" Bowed Surface
Right Handed with Grommets)

7-WBS0-9624-R
(24" Bowed Surface
Right Handed with Grommets)

24" Bowed Surface Right Handed

Item Number	List Price	Width (inches)	Depth (inches)	Weight (lbs.)
7-WBS0-1824-R	146	18	24	10
7-WBS0-2424-R	153	24	24	14
7-WBS0-3024-R	162	30	24	17
7-WBS0-3624-R	169	36	24	21
7-WBS0-4224-R	203	42	24	25
7-WBS0-4824-R	219	48	24	28
7-WBS0-5424-R	235	54	24	32
7-WBS0-6024-R	263	60	24	36
7-WBS0-6624-R	300	66	24	40
7-WBS0-7224-R	308	72	24	43
7-WBS0-7824-R	341	78	24	47
7-WBS0-8424-R	372	84	24	51
7-WBS0-9024-R	409	90	24	54
7-WBS0-9624-R	445	96	24	58
<hr/>				
7-WBSG-1824-R	166	18	24	10
7-WBSG-2424-R	173	24	24	13
7-WBSG-3024-R	181	30	24	17
7-WBSG-3624-R	188	36	24	21
7-WBSG-4224-R	224	42	24	25
7-WBSG-4824-R	240	48	24	28
<hr/>				
7-WBSG-5424-R	275	54	24	32
7-WBSG-6024-R	302	60	24	36
7-WBSG-6624-R	338	66	24	39
7-WBSG-7224-R	348	72	24	43
7-WBSG-7824-R	380	78	24	47
7-WBSG-8424-R	412	84	24	50
<hr/>				
7-WBSG-9024-R	468	90	24	54
7-WBSG-9624-R	504	96	24	58

Work Surfaces

24" Bowed Surfaces:

- 1" standard thickness
- PVC edging standard
- Grommet included {black grommet standard}

When Ordering 24" Bowed Surfaces Please Specify:

- Laminate color
- Trim color

Sample Code

7	WBS0	60	24	R
Product Family	Product Code	Width	Depth	Product Modifier

Panelink Work Surfaces

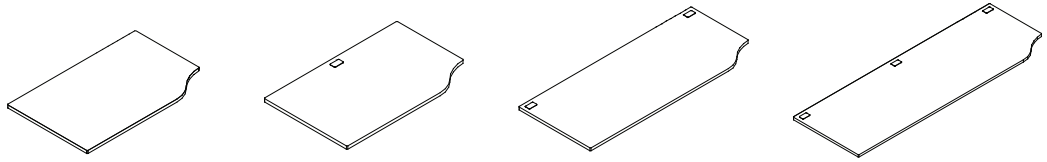

7-WBS0-4830-L
(30" Bowed Surface
Left Handed)

7-WBS0-4830-L
(30" Bowed Surface
Left Handed with Grommet)

7-WBS0-6630-L
(30" Bowed Surface
Left Handed with Grommets)

7-WBS0-9630-L
(30" Bowed Surface
Left Handed with Grommets)

30" Bowed Surface Left Handed

Item Number	List Price	Width (inches)	Depth (inches)	Weight (lbs.)
7-WBS0-1830-L	177	18	30	13
7-WBS0-2430-L	193	24	30	17
7-WBS0-3030-L	201	30	30	22
7-WBS0-3630-L	214	36	30	27
7-WBS0-4230-L	230	42	30	31
7-WBS0-4830-L	249	48	30	36
7-WBS0-5430-L	260	54	30	40
7-WBS0-6030-L	277	60	30	45
7-WBS0-6630-L	321	66	30	50
7-WBS0-7230-L	330	72	30	54
7-WBS0-7830-L	355	78	30	59
7-WBS0-8430-L	384	84	30	64
7-WBS0-9030-L	421	90	30	68
7-WBS0-9630-L	460	96	30	73
<hr/>				
7-WBSG-1830-L	197	18	30	13
7-WBSG-2430-L	212	24	30	17
7-WBSG-3030-L	219	30	30	22
7-WBSG-3630-L	234	36	30	26
7-WBSG-4230-L	249	42	30	31
7-WBSG-4830-L	270	48	30	36
<hr/>				
7-WBSG-5430-L	299	54	30	40
7-WBSG-6030-L	318	60	30	45
7-WBSG-6630-L	360	66	30	49
7-WBSG-7230-L	370	72	30	54
7-WBSG-7830-L	394	78	30	59
7-WBSG-8430-L	424	84	30	63
<hr/>				
7-WBSG-9030-L	479	90	30	68
7-WBSG-9630-L	519	96	30	72

Work Surfaces

30" Bowed Surfaces:

- 1" standard thickness
- PVC edging standard
- Grommet included {black grommet standard}

When Ordering 30" Bowed Surfaces Please Specify:

- Laminate color
- Trim color

Sample Code

7	WBS0	60	30	L
Product Family	Product Code	Width	Depth	Product Modifier

Panelink Work Surfaces

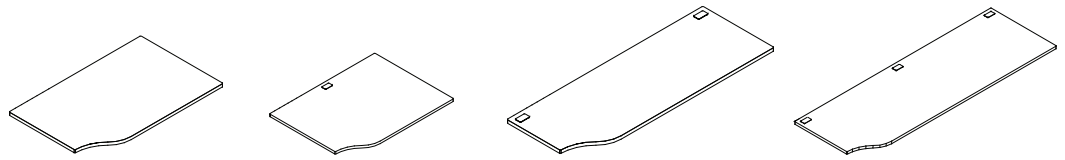

7-WBS0-4830-R
(30" Bowed Surface
Right Handed)

7-WBS0-4830-R
(30" Bowed Surface
Right Handed with Grommet)

7-WBS0-6630-R
(30" Bowed Surface
Right Handed with Grommets)

7-WBS0-9630-R
(30" Bowed Surface
Right Handed with Grommets)

30" Bowed Surface Right Handed

Item Number	List Price	Width (inches)	Depth (inches)	Weight (lbs.)
7-WBS0-1830-R	177	18	30	13
7-WBS0-2430-R	193	24	30	17
7-WBS0-3030-R	201	30	30	22
7-WBS0-3630-R	214	36	30	27
7-WBS0-4230-R	230	42	30	31
7-WBS0-4830-R	249	48	30	36
7-WBS0-5430-R	260	54	30	40
7-WBS0-6030-R	277	60	30	45
7-WBS0-6630-R	321	66	30	50
7-WBS0-7230-R	330	72	30	54
7-WBS0-7830-R	355	78	30	59
7-WBS0-8430-R	384	84	30	64
7-WBS0-9030-R	421	90	30	68
7-WBS0-9630-R	460	96	30	73
<hr/>				
7-WBSG-1830-R	197	18	30	13
7-WBSG-2430-R	212	24	30	17
7-WBSG-3030-R	219	30	30	22
7-WBSG-3630-R	234	36	30	26
7-WBSG-4230-R	249	42	30	31
7-WBSG-4830-R	270	48	30	36
<hr/>				
7-WBSG-5430-R	299	54	30	40
7-WBSG-6030-R	318	60	30	45
7-WBSG-6630-R	360	66	30	49
7-WBSG-7230-R	370	72	30	54
7-WBSG-7830-R	394	78	30	59
7-WBSG-8430-R	424	84	30	63
<hr/>				
7-WBSG-9030-R	479	90	30	68
7-WBSG-9630-R	519	96	30	72

Work Surfaces

30" Bowed Surfaces:

- 1" standard thickness
- PVC edging standard
- Grommet included {black grommet standard}

When Ordering 30" Bowed Surfaces Please Specify:

- Laminate color
- Trim color

Sample Code

7	WBS0	60	30	R
Product Family	Product Code	Width	Depth	Product Modifier

Panelink Work Surfaces

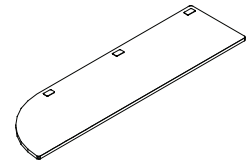
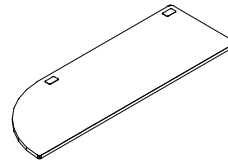
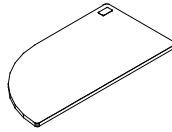
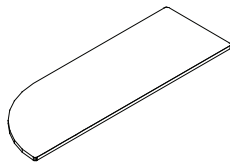

7-WRS0-6624-L
(24" Radiused Straight Surface Left Handed)

7-WRSG-3624-L
(24" Radiused Straight Surface Left Handed with Grommet)

7-WRSG-6624-L
(24" Radiused Straight Surface Left Handed with Grommets)

7-WRSG-9624-L
(24" Radiused Straight Surface Left Handed with Grommets)

24" Radiused Straight Surface Left Handed

Item Number	List Price	Width (inches)	Depth (inches)	Weight (lbs.)
7-WRS0-3024-L	231	30	24	15
7-WRS0-3624-L	239	36	24	19
7-WRS0-4224-L	270	42	24	23
7-WRS0-4824-L	286	48	24	26
7-WRS0-5424-L	315	54	24	30
7-WRS0-6024-L	327	60	24	34
7-WRS0-6624-L	354	66	24	37
7-WRS0-7224-L	373	72	24	41
7-WRS0-7824-L	403	78	24	45
7-WRS0-8424-L	432	84	24	48
7-WRS0-9024-L	468	90	24	52
7-WRS0-9624-L	503	96	24	56
<hr/>				
7-WRSG-3024-L	251	30	24	15
7-WRSG-3624-L	259	36	24	19
7-WRSG-4224-L	289	42	24	23
7-WRSG-4824-L	305	48	24	26
<hr/>				
7-WRSG-5424-L	354	54	24	30
7-WRSG-6024-L	366	60	24	34
7-WRSG-6624-L	393	66	24	37
7-WRSG-7224-L	413	72	24	41
7-WRSG-7824-L	442	78	24	45
7-WRSG-8424-L	472	84	24	48
<hr/>				
7-WRSG-9024-L	526	90	24	52
7-WRSG-9624-L	562	96	24	56

Work Surfaces

24" Radiused Straight Surfaces:

- 1" standard thickness
- PVC edging standard
- Grommet included {black grommet standard}

When Ordering 24" Radiused Straight Surfaces Please Specify:

- Laminate color
- Trim color

Sample Code

7	WRS0	60	24	L
Product Family	Product Code	Length	Depth	Product Modifier

Panelink Work Surfaces

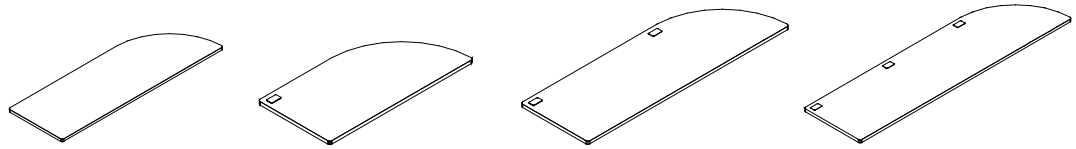

7-WRS0-6024-R
(24" Radiused Straight Surface Right Handed)

7-WRSG-4824-R
(24" Radiused Straight Surface Right Handed with Grommet)

7-WRSG-6624-R
(24" Radiused Straight Surface Right Handed with Grommets)

7-WRSG-9624-R
(24" Radiused Straight Surface Right Handed with Grommets)

24" Radiused Straight Surface Right Handed

Item Number	List Price	Width (inches)	Depth (inches)	Weight (lbs.)
7-WRS0-3024-R	231	30	24	15
7-WRS0-3624-R	239	36	24	19
7-WRS0-4224-R	270	42	24	23
7-WRS0-4824-R	286	48	24	26
7-WRS0-5424-R	315	54	24	30
7-WRS0-6024-R	327	60	24	34
7-WRS0-6624-R	354	66	24	37
7-WRS0-7224-R	373	72	24	41
7-WRS0-7824-R	403	78	24	45
7-WRS0-8424-R	432	84	24	48
7-WRS0-9024-R	468	90	24	52
7-WRS0-9624-R	503	96	24	56
<hr/>				
7-WRSG-3024-R	251	30	24	15
7-WRSG-3624-R	259	36	24	19
7-WRSG-4224-R	289	42	24	23
7-WRSG-4824-R	305	48	24	26
<hr/>				
7-WRSG-5424-R	354	54	24	30
7-WRSG-6024-R	366	60	24	34
7-WRSG-6624-R	393	66	24	37
7-WRSG-7224-R	413	72	24	41
7-WRSG-7824-R	442	78	24	45
7-WRSG-8424-R	472	84	24	48
<hr/>				
7-WRSG-9024-R	526	90	24	52
7-WRSG-9624-R	562	96	24	56

Work Surfaces

24" Radiused Straight Surfaces:
 1" standard thickness
 PVC edging standard
 Grommet included {black grommet standard}

When Ordering 24" Radiused Straight Surfaces Please Specify:

Laminate color
 Trim color

Sample Code

7	WRS0	60	24	R
Product Family	Product Code	Width	Depth	Product Modifier

Panelink Work Surfaces

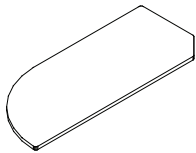

7-WRNO-6024-L
(24" Notched Radiused
Straight Surface
Left Handed)



7-WRNG-4824-L
(24" Notched Radiused
Straight Surface Left Handed
with Grommet)

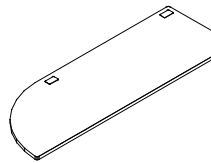

7-WRNG-6624-L
(24" Notched Radiused
Straight Surface Left Handed
with Grommets)

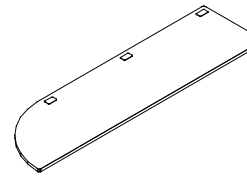

7-WRNG-9624-L
(24" Notched Radiused
Straight Surface Left Handed
with Grommets)

24" Notched Radiused Straight Surface Left Handed

Item Number	List Price	Width (inches)	Depth (inches)	Weight (lbs.)
7-WRNO-3024-L	246	30	24	14
7-WRNO-3624-L	253	36	24	19
7-WRNO-4224-L	285	42	24	22
7-WRNO-4824-L	300	48	24	26
7-WRNO-5424-L	327	54	24	30
7-WRNO-6024-L	342	60	24	33
7-WRNO-6624-L	367	66	24	37
7-WRNO-7224-L	388	72	24	41
7-WRNO-7824-L	417	78	24	45
7-WRNO-8424-L	447	84	24	48
7-WRNO-9024-L	480	90	24	52
7-WRNO-9624-L	517	96	24	56
<hr/>				
7-WRNG-3024-L	265	30	24	15
7-WRNG-3624-L	272	36	24	18
7-WRNG-4224-L	304	42	24	22
7-WRNG-4824-L	320	48	24	26
<hr/>				
7-WRNG-5424-L	366	54	24	29
7-WRNG-6024-L	381	60	24	33
7-WRNG-6624-L	408	66	24	37
7-WRNG-7224-L	427	72	24	40
7-WRNG-7824-L	456	78	24	44
7-WRNG-8424-L	486	84	24	48
<hr/>				
7-WRNG-9024-L	540	90	24	51
7-WRNG-9624-L	576	96	24	55

Work Surfaces

24" Notched Radiused Straight Surfaces:

- 1" standard thickness
- PVC edging standard
- Grommet included {black grommet standard}

When Ordering 24" Notched Radiused Straight Surfaces Please Specify:

- Laminate color
- Trim color

Sample Code

7	WRNG	60	24	L
Product Family	Product Code	Width	Depth	Product Modifier

Panelink Work Surfaces

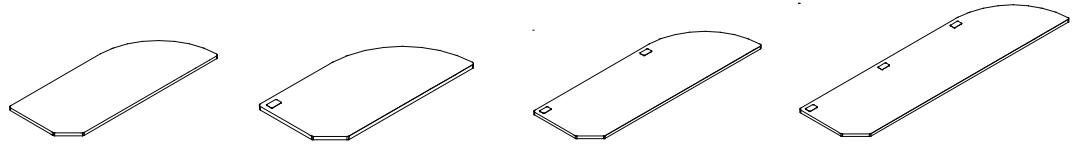

7-WRN0-6024-R
(24" Notched Radiused
Straight Surface
Right Handed)

7-WRNG-4824-R
(24" Notched Radiused
Straight Surface Right Handed
with Grommet)

7-WRNG-6624-R
(24" Notched Radiused
Straight Surface Right Handed
with Grommets)

7-WRNG-9624-R
(24" Notched Radiused
Straight Surface Right Handed
with Grommets)

24" Notched Radiused Straight Surface Right Handed

Item Number	List Price	Width (inches)	Depth (inches)	Weight (lbs.)
7-WRN0-3024-R	246	30	24	14
7-WRN0-3624-R	253	36	24	19
7-WRN0-4224-R	285	42	24	22
7-WRN0-4824-R	300	48	24	26
7-WRN0-5424-R	327	54	24	30
7-WRN0-6024-R	342	60	24	33
7-WRN0-6624-R	367	66	24	37
7-WRN0-7224-R	388	72	24	41
7-WRN0-7824-R	417	78	24	45
7-WRN0-8424-R	447	84	24	48
7-WRN0-9024-R	480	90	24	52
7-WRN0-9624-R	517	96	24	56
<hr/>				
7-WRNG-3024-R	265	30	24	15
7-WRNG-3624-R	272	36	24	18
7-WRNG-4224-R	304	42	24	22
7-WRNG-4824-R	320	48	24	26
<hr/>				
7-WRNG-5424-R	366	54	24	29
7-WRNG-6024-R	381	60	24	33
7-WRNG-6624-R	408	66	24	37
7-WRNG-7224-R	427	72	24	40
7-WRNG-7824-R	456	78	24	44
7-WRNG-8424-R	486	84	24	48
<hr/>				
7-WRNG-9024-R	540	90	24	51
7-WRNG-9624-R	576	96	24	55

Work Surfaces

24" Notched Radiused Straight Surfaces:

- 1" standard thickness
- PVC edging standard
- Grommet included {black grommet standard}

When Ordering 24" Notched Radiused Straight Surfaces Please Specify:

- Laminate color
- Trim color

Sample Code

7	WRNG	60	24	L
Product Family	Product Code	Width	Depth	Product Modifier

Panelink Work Surfaces

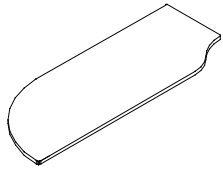

7-WRB0-6024-L
(24" Bowed Radiused Straight Surface Left Handed)

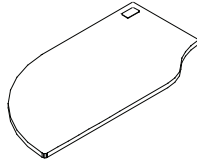

7-WRBG-4824-L
(24" Bowed Radiused Straight Surface Left Handed with Grommet)

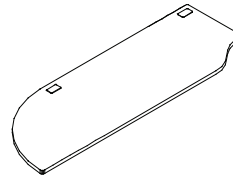

7-WRBG-6624-L
(24" Bowed Radiused Straight Surface Left Handed with Grommets)

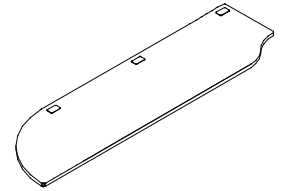

7-WRBG-9624-L
(24" Bowed Radiused Straight Surface Left Handed with Grommets)

24" Bowed Radiused Straight Surface Left Handed

Item Number	List Price	Width (inches)	Depth (inches)	Weight (lbs.)
7-WRB0-3624-L	262	36	24	18
7-WRB0-4224-L	294	42	24	22
7-WRB0-4824-L	308	48	24	25
7-WRB0-5424-L	336	54	24	29
7-WRB0-6024-L	351	60	24	33
7-WRB0-6624-L	377	66	24	36
7-WRB0-7224-L	396	72	24	40
7-WRB0-7824-L	427	78	24	44
7-WRB0-8424-L	455	84	24	47
7-WRB0-9024-L	491	90	24	51
7-WRB0-9624-L	526	96	24	55
<hr/>				
7-WRBG-3624-L	282	36	24	18
7-WRBG-4224-L	314	42	24	21
7-WRBG-4824-L	328	48	24	25
<hr/>				
7-WRBG-5424-L	377	54	24	29
7-WRBG-6024-L	391	60	24	32
7-WRBG-6624-L	415	66	24	36
7-WRBG-7224-L	437	72	24	40
7-WRBG-7824-L	467	78	24	43
7-WRBG-8424-L	495	84	24	47
<hr/>				
7-WRBG-9024-L	550	90	24	51
7-WRBG-9624-L	585	96	24	54

Work Surfaces

24" Bowed Radiused Straight Surfaces:
 1" standard thickness
 PVC edging standard
 Grommet included {black grommet standard}

When Ordering 24" Bowed Radiused Straight Surfaces Please Specify:

Laminate color
 Trim color

Sample Code

7	WRBG	60	24	L
Product Family	Product Code	Width	Depth	Product Modifier

Panelink Work Surfaces

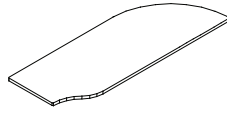

7-WRB0-6024-R
(24" Bowed Radiused Straight Surface Right Handed)

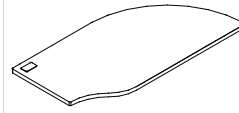

7-WRBG-4824-R
(24" Bowed Radiused Straight Surface Right Handed with Grommet)

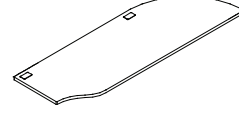

7-WRBG-6624-R
(24" Bowed Radiused Straight Surface Right Handed with Grommets)

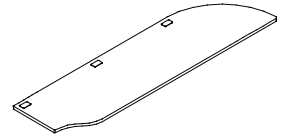

7-WRBG-9624-R
(24" Bowed Radiused Straight Surface Right Handed with Grommets)

24" Bowed Radiused Straight Surface Right Handed

Item Number	List Price	Width (inches)	Depth (inches)	Weight (lbs.)
7-WRB0-3624-R	262	36	24	18
7-WRB0-4224-R	294	42	24	22
7-WRB0-4824-R	308	48	24	25
7-WRB0-5424-R	336	54	24	29
7-WRB0-6024-R	351	60	24	33
7-WRB0-6624-R	377	66	24	36
7-WRB0-7224-R	396	72	24	40
7-WRB0-7824-R	427	78	24	44
7-WRB0-8424-R	455	84	24	47
7-WRB0-9024-R	491	90	24	51
7-WRB0-9624-R	526	96	24	55
<hr/>				
7-WRBG-3624-R	282	36	24	18
7-WRBG-4224-R	314	42	24	21
7-WRBG-4824-R	328	48	24	25
<hr/>				
7-WRBG-5424-R	377	54	24	29
7-WRBG-6024-R	391	60	24	32
7-WRBG-6624-R	415	66	24	36
7-WRBG-7224-R	437	72	24	40
7-WRBG-7824-R	467	78	24	43
7-WRBG-8424-R	495	84	24	47
<hr/>				
7-WRBG-9024-R	550	90	24	51
7-WRBG-9624-R	585	96	24	54

Work Surfaces

24" Bowed Radiused Straight Surfaces:
 1" standard thickness
 PVC edging standard
 Grommet included {black grommet standard}

When Ordering 24" Bowed Radiused Straight Surfaces Please Specify:
 Laminate color
 Trim color

Sample Code

7	WRBG	60	24	R
Product Family	Product Code	Width	Depth	Product Modifier

Panelink Work Surfaces

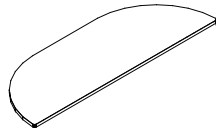

7-WRR0-7224
(Double Radiused Surface)

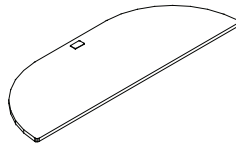

7-WRRG-6624
(Double Radiused Surface with Grommet)

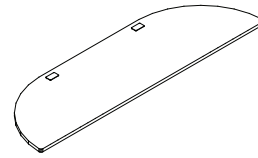

7-WRRG-7224
(Double Radiused Surface with Grommets)

Double Radiused

Item Number	List Price	Width (inches)	Depth (inches)	Weight (lbs.)
7-WRR0-4824	319	48	24	23
7-WRR0-5424	347	54	24	27
7-WRR0-6024	361	60	24	31
7-WRR0-6624	388	66	24	34
7-WRR0-7224	409	72	24	38
7-WRR0-7824	440	78	24	42
7-WRR0-8424	469	84	24	45
7-WRR0-9024	505	90	24	49
7-WRR0-9624	542	96	24	53
7-WRRG-4824	337	48	24	23
7-WRRG-5424	366	54	24	27
7-WRRG-6024	381	60	24	31
7-WRRG-6624	408	66	24	34
7-WRRG-7224	448	72	24	38
7-WRRG-7824	478	78	24	41
7-WRRG-8424	508	84	24	45
7-WRRG-9024	545	90	24	49
7-WRRG-9624	582	96	24	53

Work Surfaces

Double Radiused Straight Surfaces:

1" standard thickness
PVC edging standard
Grommet included {black grommet standard}

When Ordering Double Radiused Straight Surfaces Please Specify:

Laminate color
Trim color

Sample Code

7	WRRG	60	24
Product Family	Product Code	Width	Depth

Panelink Work Surfaces

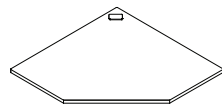

7-W5S0-3618
(36" Straight Front
Five Sided Corner)

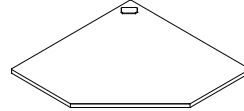

7-W5S0-4224
(42" Straight Front
Five Sided Corner)

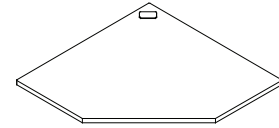

7-W5S0-4824
(48" Straight Front
Five Sided Corner)

Five Sided Surfaces Straight Front

Item Number	List Price	Width (inches)	Depth (inches)	Weight (lbs.)
7-W5S0-3618	356	36	18	27
7-W5S0-3624	356	36	24	30
7-W5S0-4224	429	42	24	39
7-W5S0-4824	449	48	24	47
7-W5S0-4830	449	48	30	53

Work Surfaces

Five Sided Corner Work Surfaces:

- 1" standard thickness
- PVC edging standard
- Desktop Power Available
- Grommet included {black grommet standard}

When Ordering Five Sided Corner Work Surfaces Please Specify:

- Laminate color
- Trim color

Sample Code

7	W5S0	48	24	P
Product Family	Product Code	Width	Depth	Product Modifier

Panelink Work Surfaces

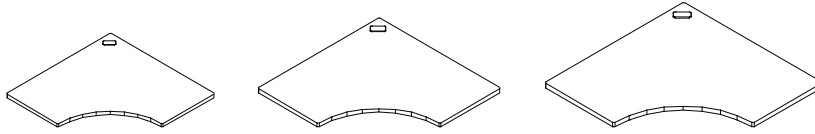

7-W5C0-3618
(36" Curved Front
Five Sided Corner)

7-W5C0-4224
(42" Curved Front
Five Sided Corner)

7-W5C0-4824
(48" Curved Front
Five Sided Corner)

Five Sided Surfaces Curved Front

Item Number	List Price	Width (inches)	Depth (inches)	Weight (lbs.)
7-W5C0-3618	356	36	18	27
7-W5C0-3624	356	36	24	30
7-W5C0-4224	429	42	24	39
7-W5C0-4824	449	48	24	47
7-W5C0-4830	449	48	30	53

Work Surfaces

Five Sided Corner Work Surfaces:

- 1" standard thickness
- PVC edging standard
- Grommet included {black grommet standard}

When Ordering Five Sided Corner Work Surfaces Please Specify:

- Laminate color
- Trim color

Sample Code

7	W5C0	48	24	P
Product Family	Product Code	Width	Depth	Product Modifier

Panelink Work Surfaces

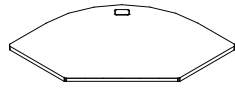

7-WXS0-3618
(36" Straight Front
Radius Panel Surface)

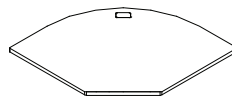

7-WXS0-4224
(42" Straight Front
Radius Panel Surface)

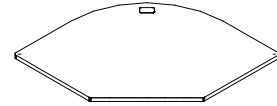

7-WXS0-4824
(48" Straight Front
Radius Panel Surface)

Radius Panel Surfaces Straight Front

Item Number	List Price	Width (inches)	Depth (inches)	Weight (lbs.)
7-WXS0-3618	384	36	18	23
7-WXS0-3624	384	36	24	27
7-WXS0-4224	462	42	24	35
7-WXS0-4824	522	48	24	44
7-WXS0-4830	522	48	30	49

Work Surfaces

Radius Panel Work Surfaces:

- 1" standard thickness
- PVC edging standard
- Grommet included {black grommet standard}

When Ordering Radius Panel Work Surfaces Please Specify:

- Laminate color
- Trim color

Sample Code

7	WXS0	48	24	P
Product Family	Product Code	Length	Depth	Product Modifier

Panelink Work Surfaces

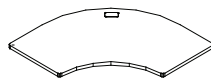

7-WXC0-3618
(36" Curved Front
Radius Panel Surface)

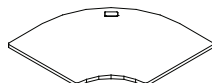

7-WXC0-4224
(42" Curved Front Radius
Panel Surface
with Pop-up Grommet)

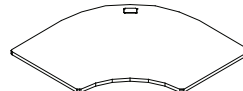

7-WXC0-4824
(48" Curved Front
Radius Panel Surface)

Radius Panel Surfaces Curved Front

Item Number	List Price	Width (inches)	Depth (inches)	Weight (lbs.)
7-WXC0-3618	450	36	18	23
7-WXC0-3624	450	36	24	27
7-WXC0-4224	522	42	24	35
7-WXC0-4824	550	48	24	44
7-WXC0-4830	550	48	30	49

Radius Panel Work Surfaces:

- 1" standard thickness
- PVC edging standard
- Grommet included {black grommet standard}

When Ordering Radius Panel Work Surfaces Please Specify:

- Laminate color
- Trim color

Sample Code

7	WXC0	48	24	P
Product Family	Product Code	Width	Depth	Product Modifier

Panelink Work Surfaces

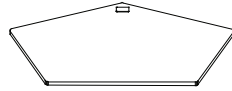

7-WAS0-3024
(24° Angled Corner
with Straight Front)

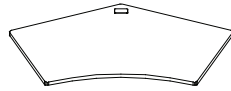

7-WAC0-3024
(30° Angled Corned
with Curved Front)

Angled Surfaces

Item Number	List Price	Width (inches)	Depth (inches)	Weight (lbs.)
7-WAS0-2424	334	24	24	24
7-WAS0-3024	347	30	24	32
7-WAC0-2424	402	24	24	24
7-WAC0-3024	415	30	24	32

Work Surfaces

Angled Work Surfaces:

- 1" standard thickness
- PVC edging standard
- Grommet included {black grommet standard}

When Ordering Angled Surfaces Please Specify:

- Laminate color
- Trim color

Sample Code

7	WAC0	30	24	P
Product Family	Product Code	Width	Depth	Product Modifier

Panelink Work Surfaces

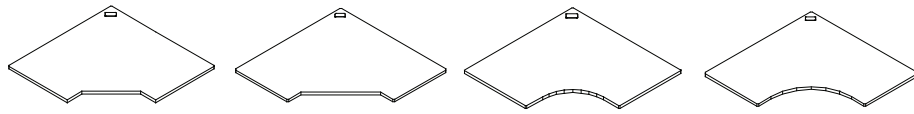

7-WENS-4224
(42" Extended Corner
with Straight Front)

7-WENS-4824
(48" Extended Corner
with Straight Front)

7-WENC-4224
(42" Extended Corner
with Curved Front)

7-WENC-4824
(48" Extended Corner
with Curved Front)

Extended Corner Surfaces

Item Number	List Price	Width (inches)	Depth (inches)	Weight (lbs.)
7-WENS-4218	429	42	18	35
7-WENS-4224	429	42	24	39
7-WENS-4824	449	48	24	48
7-WENC-4218	484	42	18	38
7-WENC-4224	484	42	24	38
7-WENC-4824	504	48	24	46

Extended Corner Work Surfaces:

1" standard thickness
PVC edging standard
Grommet included {black grommet standard}

When Ordering Extended Corner Work Surfaces Please Specify:

Laminate color
Trim color

Sample Code

7	WENC	48	24
Product Family	Product Code	Width	Depth

Panelink Work Surfaces

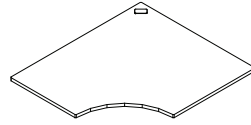
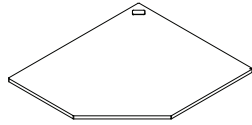

7-WMS0-4824-L
(Left Handed
Multifunctional Surface
with Straight Front)

7-WMC0-4824-R
(Right Handed
Multifunctional Surface
with Curved Front)

Multifunctional Surfaces

Item Number	List Price	Width (inches)	Depth (inches)	Weight (lbs.)
7-WMS0-4842-L	449	48	42	48
7-WMS0-4842-R	449	48	42	48
7-WMC0-4842-L	493	48	42	45
7-WMC0-4842-R	493	48	42	45

Work Surfaces

Multifunctional Corner Surfaces:

- 1" standard thickness
- PVC edging standard
- Grommet included {black grommet standard}

When Ordering multifunctional Corner Surfaces Please Specify:

- Laminate color
- Trim color

Sample Code

7	WMC0	48	24	L
Product Family	Product Code	Width	Depth	Product Modifier

Panelink Work Surfaces

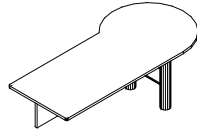

7-WP00-7830-L
(Left Handed Panel
Mounted "P" Table)

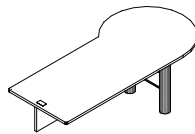

7-WP0G-7830-L
(Left Handed Panel
Mounted "P" Table
With Grommet)

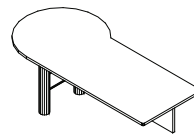

7-WP00-6030-R
(Right Handed Panel
Mounted "P" Table)

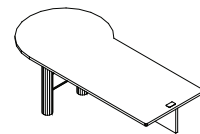

7-WP0G-6030-R
(Right Handed Panel
Mounted "P" Table
With Grommet)

"P" Tables Panel Mounted

Item Number	List Price	Width (inches)	Depth (inches)	Weight (lbs.)
7-WP00-6030-L	469	60	30	73
7-WP00-6630-L	533	66	30	80
7-WP00-7230-L	568	72	30	86
7-WP00-7830-L	667	78	30	93
7-WP00-8430-L	718	84	30	99
7-WP0G-6030-L	489	60	30	73
7-WP0G-6630-L	552	66	30	80
7-WP0G-7230-L	587	72	30	86
7-WP0G-7830-L	686	78	30	93
7-WP0G-8430-L	738	84	30	99
7-WP00-6030-R	469	60	30	73
7-WP00-6630-R	533	66	30	80
7-WP00-7230-R	568	72	30	86
7-WP00-7830-R	667	78	30	93
7-WP00-8430-R	718	84	30	99
7-WP0G-6030-R	489	60	30	73
7-WP0G-6630-R	552	66	30	80
7-WP0G-7230-R	587	72	30	86
7-WP0G-7830-R	686	78	30	93
7-WP0G-8430-R	738	84	30	99

"P" Tables:

- 1" standard thickness
- PVC edging standard
- Grommet included {black grommet standard}

When Ordering "P" Tables Please Specify:

- Laminate color
- Trim color
- Metal support color

Sample Code

7	WP00	60	30	R
Product Family	Product Code	Width	Depth	Product Modifier

Panelink Work Surfaces

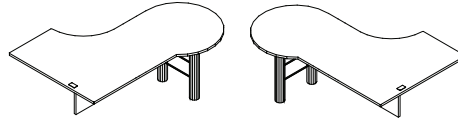

7-WY0G-6048-L
(Left Handed Panel
Mounted "Y" Table
With Grommet)

7-WY0G-6048-R
(Right Handed Panel
Mounted "Y" Table
With Grommet)

"Y" Tables Panel Mounted

Item Number	List Price	Width (inches)	Depth (inches)	Weight (lbs.)
7-WY0G-6048-L	991	60	48	86
7-WY0G-6648-L	1014	66	48	93
7-WY0G-7248-L	1028	72	48	99
7-WY0G-7848-L	1053	78	48	106
7-WY0G-8448-L	1067	84	48	112
7-WY0G-9048-L	1082	90	48	118
7-WY0G-9648-L	1096	96	48	125
7-WY0G-6048-R	991	60	48	86
7-WY0G-6648-R	1014	66	48	93
7-WY0G-7248-R	1028	72	48	99
7-WY0G-7848-R	1053	78	48	106
7-WY0G-8448-R	1067	84	48	112
7-WY0G-9048-R	1082	90	48	118
7-WY0G-9648-R	1096	96	48	125

Work Surfaces

"Y" Tables:

- 1" standard thickness
- PVC edging standard
- Grommet included {black grommet standard}

When Ordering "Y" Tables Please Specify:

- Laminate color
- Trim color
- Metal support color

Sample Code

7	WY00	60	48	R
Product Family	Product Code	Width	Depth	Product Modifier

Panelink Work Surfaces

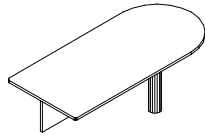

7-WD00-6030
(30" "D" Table)

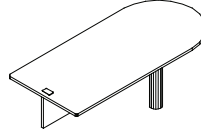

7-WD0G-6030
(30" "D" Table
with Grommet)

30" "D" Tables Panel Mounted

Item Number	List Price	Width (inches)	Depth (inches)	Weight (lbs.)
7-WD00-6030	429	60	30	63
7-WD00-6630	507	66	30	70
7-WD00-7230	548	72	30	76
7-WD00-7830	632	78	30	83
7-WD00-8430	667	84	30	89
7-WD0G-6030	448	60	30	63
7-WD0G-6630	526	66	30	70
7-WD0G-7230	567	72	30	76
7-WD0G-7830	654	78	30	83
7-WD0G-8430	686	84	30	89

Work Surfaces

"D" Tables:

- 1" standard thickness
- PVC edging standard
- Grommet included {black grommet standard}

When Ordering "D" Tables Please Specify:

- Laminate color
- Trim color
- Metal support color

Sample Code

7	WD00	60	30
Product Family	Product Code	Width	Depth

Panelink Work Surfaces

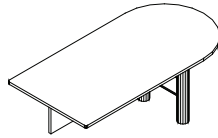

7-WD00-7236
(36" "D" Table)

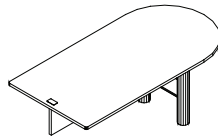

7-WD0G-6036
(36" "D" Table
with Grommet)

36" "D" Tables Panel Mounted

Item Number	List Price	Width (inches)	Depth (inches)	Weight (lbs.)
7-WD00-6036	472	60	36	78
7-WD00-6636	559	66	36	86
7-WD00-7236	602	72	36	93
7-WD00-7836	698	78	36	100
7-WD00-8436	734	84	36	108
7-WD0G-6036	491	60	36	78
7-WD0G-6636	579	66	36	86
7-WD0G-7236	622	72	36	93
7-WD0G-7836	716	78	36	100
7-WD0G-8436	753	84	36	108

Work Surfaces

"D" Tables:

- 1" standard thickness
- PVC edging standard
- Grommet included {black grommet standard}

When Ordering "D" Tables Please Specify:

- Laminate color
- Trim color
- Metal support color

Sample Code

7	WD00	60	36
Product Family	Product Code	Width	Depth

Panelink Work Surfaces

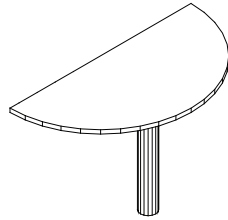

7-WC00-48
("C" Table)

Extension Table

Item Number	List Price	Width (inches)	Depth (inches)	Weight (lbs.)
7-WC00-48	474	48	48	23
7-WC00-50	474	50	50	26
7-WC00-60	500	60	60	36
7-WC00-62	510	62	62	39

Work Surfaces

Extension Tables:
1" standard thickness
PVC edging standard

When Ordering Extension Tables Please Specify:

Laminate color
Trim color
Metal color
Support color

Sample Code

7	WQ00	36	24
Product Family	Product Code	Width	Depth

Panelink Surface Supports

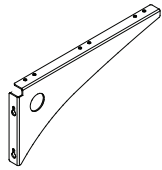

7-CCAB-22-L
(Cantilever Arm)

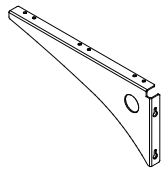

7-CCAB-22-R
(Cantilever Arm)

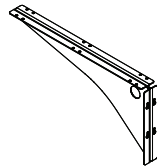

7-CCAB-22
(Cantilever Arm)

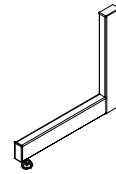

7-HPCF-14
(Cantilever Foot)



7-CPM0-02
(Modesty Post)

Metal Supports

Item Number	List Price	Length (inches)	Depth (inches)	Weight (lbs.)
7-CCAB-16-L	58	16	1	3
7-CCAB-22-L	63	22	1	3
7-CCAB-16-R	58	16	1	3
7-CCAB-22-R	63	22	1	3
7-CCAB-16	58	16	1	3
7-CCAB-22	63	22	1	3
7-HPCF-14	63	14	1	3
7-CPM0-02	94	29	1	1

Metal Supports:
Powder coated metal
Available in black only

Sample Code

7	CCA0	22
Product Family	Product Code	Length

Panelink Surface Supports

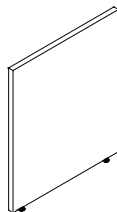

7-CGU0-24
(Universal Gable Support)



7-CGUC-12
(Universal Gable Support with Cut Out)

Laminate Supports

Item Number	List Price	Depth (inches)	Weight (lbs.)
7-CGU0-12	134	12	8
7-CGU0-18	144	18	11
7-CGU0-21	155	21	11
7-CGU0-24	155	24	15
7-CGU0-30	187	30	19
7-CGU0-36	202	36	22
7-CGUC-12	134	12	8
7-CGUC-18	144	18	11

Surface Supports

Laminate Supports:

Designed to support work surfaces

When Ordering Laminate Supports Please Specify:

Laminate color

Trim color

Sample Code

7	CGUO	22
Product Family	Product Code	Depth

Panelink Modesties

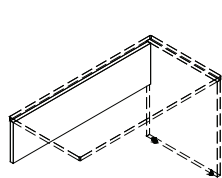

7-CMIO-4612
(Partial Internal Modesty)

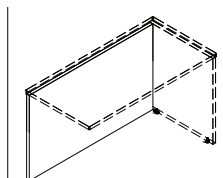

7-CMIO-4628
(Full Internal Modesty)

Internal Modesties

Item Number	List Price	Width (inches)	Depth (inches)	Weight (lbs.)
7-CMIO-1612	79	16	12	5
7-CMIO-2212	86	22	12	6
7-CMIO-2812	92	28	12	8
7-CMIO-3412	97	34	12	10
7-CMIO-4012	108	40	12	11
7-CMIO-4612	118	46	12	13
7-CMIO-5212	124	52	12	15
7-CMIO-5812	131	58	12	16
7-CMIO-6412	138	64	12	18
7-CMIO-7012	144	70	12	20
7-CMIO-7612	151	76	12	21
7-CMIO-8212	156	82	12	23
7-CMIO-8812	165	88	12	25
7-CMIO-9412	169	94	12	26
<hr/>				
7-CMIO-1628	79	16	28	10
7-CMIO-2228	86	22	28	14
7-CMIO-2828	92	28	28	17
7-CMIO-3428	97	34	28	21
7-CMIO-4028	108	40	28	24
7-CMIO-4628	118	46	28	28
7-CMIO-5228	124	52	28	35
7-CMIO-5828	131	58	28	35
7-CMIO-6428	138	64	28	39
7-CMIO-7028	144	70	28	43
7-CMIO-7628	151	76	28	46
7-CMIO-8228	156	82	28	50
7-CMIO-8828	165	88	28	53
7-CMIO-9428	169	94	28	60

Modesties

Internal Modesties:
1" standard thickness
PVC edging standard

When Ordering Internal Modesties Please Specify:
Laminate color
Trim color

Sample Code

7	CMIO	52	12
Product Family	Product Code	Width	Depth

Panelink Modesties

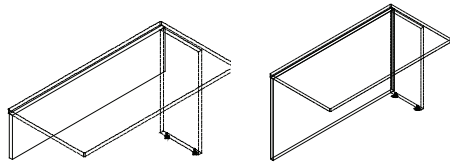

7-CME0-4812
(Partial External Modesty)

7-CME0-4828
(Full External Modesty)

External Modesties

Item Number	List Price	Width (inches)	Depth (inches)	Weight (lbs.)
7-CME0-1812	79	18	12	5
7-CME0-2412	86	24	12	7
7-CME0-3012	92	30	12	9
7-CME0-3612	97	36	12	11
7-CME0-4212	108	42	12	13
7-CME0-4812	118	48	12	15
7-CME0-5412	124	54	12	16
7-CME0-6012	131	60	12	18
7-CME0-6612	138	66	12	20
7-CME0-7212	144	72	12	22
7-CME0-7812	151	78	12	24
7-CME0-8412	156	84	12	26
7-CME0-9012	165	90	12	28
7-CME0-9612	169	96	12	29
<hr/>				
7-CME0-1828	79	18	28	11
7-CME0-2428	86	24	28	15
7-CME0-3028	92	30	28	19
7-CME0-3628	97	36	28	23
7-CME0-4228	108	42	28	27
7-CME0-4828	118	48	28	31
7-CME0-5428	124	54	28	35
7-CME0-6028	131	60	28	39
7-CME0-6628	138	66	28	43
7-CME0-7228	144	72	28	47
7-CME0-7828	151	78	28	51
7-CME0-8428	156	84	28	55
7-CME0-9028	165	90	28	59
7-CME0-9628	169	96	28	63

Modesties

External Modesties:

1" standard thickness
PVC edging standard

When Ordering External Modesties Please Specify:

Laminate color
Trim color

Sample Code

7	CME0	54	28
Product Family	Product Code	Width	Depth

Panelink Freestanding Desks

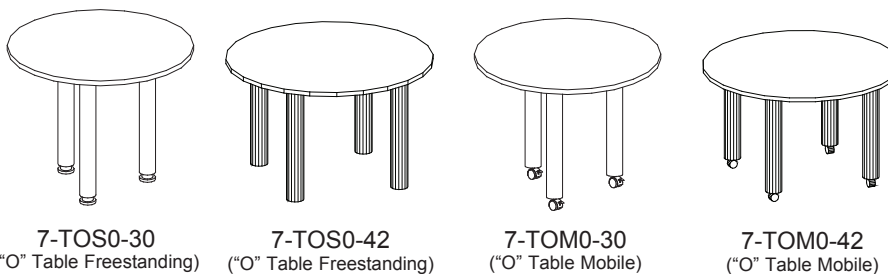

Breakaway Tables

Item Number	List Price	Diameter (inches)	Depth (inches)	Weight (lbs.)
7-TOS0-30	468	30	30	41
7-TOS0-36	495	36	36	49
7-TOS0-42	523	42	42	58
7-TOS0-48	550	42	42	69
7-TOM0-30	590	30	30	39
7-TOM0-36	643	36	36	47
7-TOM0-42	694	42	42	57
7-TOM0-48	700	48	48	68

Freestanding Desks

Breakaway Tables:

- Grommet included {black grommet standard}
- Includes base
- Includes all necessary assembly hardware
- PVC edging standard

When Ordering Breakaway Tables Please Specify:

- Laminate color
- Trim color
- Metal color

Sample Code

7	TQM0	46	30
Product Family	Product Code	Diameter	Depth

Panelink Storage

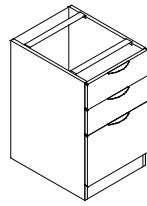

7-FPBU-1618
(Under Desk
Box/Box/File)

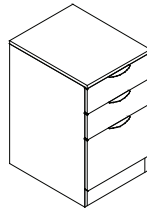

7-FPBF-1621
(Freestanding
Box/Box/File)

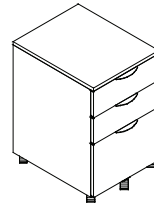

7-FPBM-1621
(Mobile
Box/Box/File)

Laminate Box/Box/File Pedestals

Item Number	List Price	Width (inches)	Depth (inches)	Weight (lbs.)
7-FPBU-1618	516	16	18	58
7-FPBF-1618	634	16	21	67
7-FPBM-1618	679	16	21	68

Storage

Pedestals:

Includes lock
Pencil tray included
Will allow for either legal or letter size filing

When Ordering Pedestals Please Specify:

Laminate color
Trim color

Sample Code

7	FPBF	17	21
Product Family	Product Code	Width	Depth

Panelink Storage

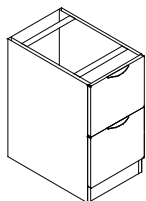

7-FPFU-1618
(Under Desk
File/File)

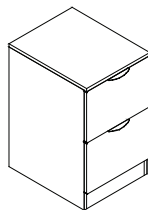

7-FPFF-1621
(Freestanding
File/File)

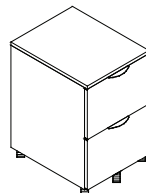

7-FPFM-1621
(Mobile
File/File)

Laminate File/File Pedestals

Item Number	List Price	Width (inches)	Depth (inches)	Weight (lbs.)
7-FPFU-1618	516	16	18	58
7-FPFF-1621	634	16	21	67
7-FPFM-1621	679	16	21	68

Storage

Pedestals:

Includes lock
Pencil tray included
Will allow for either legal or letter size filing

When Ordering Pedestals Please Specify:

Laminate color
Trim color

Sample Code

7	FPFU	17	21
Product Family	Product Code	Width	Depth

Panelink Storage

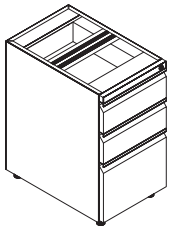

7-FPBU-1523-S
(Metal Under Desk
Box/Box/File,
No Bracket)

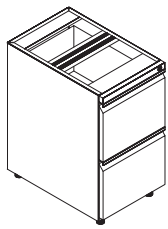

7-FPBU-1523-S
(Metal Under Desk
File/File,
No Bracket)

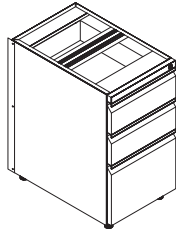

7-FPBU-1524-S-L
(Metal Under Desk
Box/Box/File,
Left Bracket)

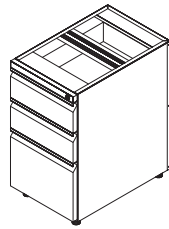

7-FPBU-1524-S-R
(Metal Under Desk
Box/Box/File,
Right Bracket)

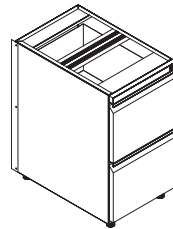

7-FPFU-1524-S-L
(Metal Under Desk
File/File,
Left Bracket)

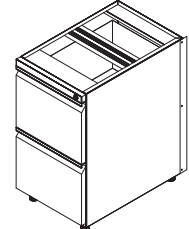

7-FPFU-1524-S-R
(Metal Under Desk
File/File,
Right Bracket)

Metal Pedestals

Item Number	List Price	Width (inches)	Depth (inches)	Weight (lbs.)
7-FPBU-1523-S	352	15	23	92
7-FPBU-1524-S-L	397	15	24	92
7-FPBU-1524-S-R	397	15	24	92
7-FPBU-1530-S-L	417	15	30	92
7-FPBU-1530-S-R	417	15	30	92
7-FPFU-1523-S	325	15	23	92
7-FPFU-1524-S-L	370	15	24	92
7-FPFU-1524-S-R	370	15	24	92
7-FPFU-1530-S-L	390	15	30	92
7-FPFU-1530-S-R	390	15	30	92

Metal Pedestals:

Available in file/file or box/box/file configurations
Includes lock, keyed randomly
Pencil tray included in top drawer
Will allow for either legal or letter size filing

When Ordering Metal Pedestals Please Specify:

Silver or White colour
Right or Left hand
Depth of worksurface under which the pedestal will be located.

Sample Code

7	FPBU	15	24	S	L
Product Family	Product Code	Width	Depth	Case Finish	Hand

Panelink Storage

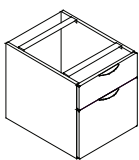

7-FPSU-1618
(Suspended Box/File
Pedestal)

Suspended Box/File Pedestals

Item Number	List Price	Width (inches)	Depth (inches)	Weight (lbs.)
7-FPSU-1618	369	16	18	44

Storage

Pedestals:

- Includes lock
- Pencil tray included
- Will allow for either legal or letter size filing

When Ordering Pedestals Please Specify:

- Laminate color
- Trim color

Sample Code

7	FPSU	17	21
Product Family	Product Code	Width	Depth

Panelink Storage

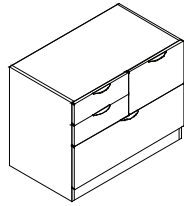

7-FPJU-3621
(Under Desk Joined Box/
Box/File Cabinet)

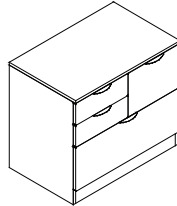

7-FPJF-3621
(Freestanding Joined Box/
Box/File Cabinet)

Joined Lateral Cabinets Box/Box/File	Item Number	List Price	Width (inches)	Depth (inches)	Weight (lbs.)
	7-FPJU-3621	1000	36	21	130
	7-FPJF-3621	1023	36	21	130

Storage

Cabinets:
Includes lock
Pencil tray included
Will allow for either legal or letter size filing

When Ordering Cabinets Please Specify:
Laminate color
Trim color

Sample Code

7	FPJU	36	21
Product Family	Product Code	Width	Depth

Panelink Storage

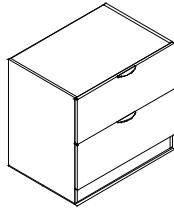

7-FL2U-3621
(Under Desk Two Drawer
Lateral Filing Cabinet)

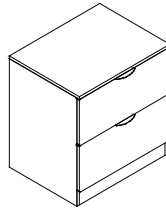

7-FL2F-3621
(Freestanding Two Drawer
Lateral Filing Cabinet)

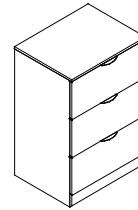

7-FL3F-3621
(Freestanding Three
Drawer Lateral
Filing Cabinet)

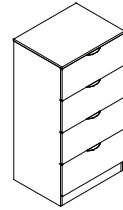

7-FL4F-3621
(Freestanding Four
Drawer Lateral
Filing Cabinet)

Lateral Filing Cabinets

Item Number	List Price	Width (inches)	Depth (inches)	Weight (lbs.)
7-FL2U-3021	816	30	21	107
7-FL2U-3621	854	36	21	130
7-FL2U-4221	912	42	21	150
7-FL2F-3021	844	30	21	107
7-FL2F-3621	878	36	21	130
7-FL2F-4221	959	42	21	150
7-FL3F-3021	1009	30	21	167
7-FL3F-3621	1059	36	21	180
7-FL4F-3021	1500	30	21	200
7-FL4F-3621	1618	36	21	240

Storage

Cabinets:

Includes lock

Will allow for either legal or letter size filing

When Ordering Cabinets Please Specify:

Laminate color

Trim color

Sample Code

7	FL2U	36	21
Product Family	Product Code	Width	Depth

Panelink Storage

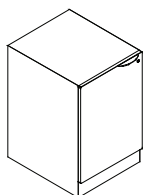

7-FSU0-1821-L
(Under Desk Single
Door Cabinet)

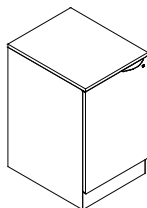

7-FSFO-1821-L
(Freestanding Single
Door Cabinet)

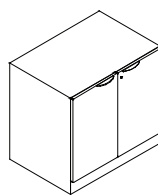

7-FSU0-3621
(Under Desk Double
Door Cabinet)

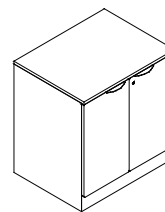

7-FSFO-3621
(Freestanding Double
Door Cabinet)

Single Height Cabinets

Item Number	List Price	Width (inches)	Depth (inches)	Weight (lbs.)
7-FSU0-1821-L	440	18	21	80
7-FSU0-1821-R	440	18	21	80
7-FSFO-1821-L	461	18	21	80
7-FSFO-1821-R	461	18	21	80
7-FSU0-3021	632	30	21	107
7-FSU0-3621	719	36	21	130
7-FSFO-3021	665	30	21	107
7-FSFO-3621	752	36	21	130

Storage

Cabinets:
Includes lock
Includes shelf

When Ordering Cabinets Please Specify:
Laminate color
Trim color

Sample Code

7	FSF0	36	21
Product Family	Product Code	Width	Depth

Panelink Storage

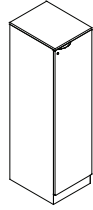

7-FSDB-1821-R
(Single Door Cabinet with
Coat Bar Right Handed)

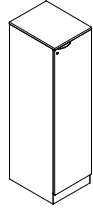

7-FSDC-1824-R
(Single Door Cabinet with
Coat Bar and Shelves
Right Handed)

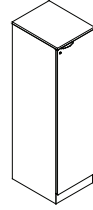

7-FSDS-1821-R
(Single Door Cabinet
with Shelves)

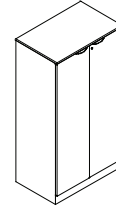

7-FSDS-3621
(Double Door Cabinet
with Shelves)

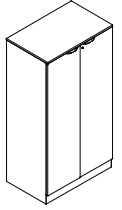

7-FSDB-3621
(Double Door Cabinet
with Coat Bar)

Double Height Cabinets

Item Number	List Price	Width (inches)	Depth (inches)	Height (inches)	Weight (lbs.)
7-FSDB-1821-L	876	18	21	66	140
7-FSDB-1821-R	876	18	21	66	140
7-FSDC-2421-L	1078	24	21	66	150
7-FSDC-2421-R	1078	24	21	66	150
7-FSDS-1821-L	876	18	21	66	160
7-FSDS-1821-R	876	18	21	66	160
7-FSDS-3621	1130	36	21	66	195
7-FSDB-3621	1130	36	21	66	195

Storage

Cabinets:
Includes lock

When Ordering Cabinets Please Specify:
Laminate color
Trim color

Sample Code

7	FSDS	36	21
Product Family	Product Code	Width	Depth

Panelink Storage



7-FCSB-1821-R
(Right Handed
FB/FCS Cabinet)



7-FCSF-1821-R
(Right Handed
FF/FCS Cabinet)

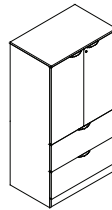

7-FCSL-3621
(FL/FCS Cabinet)

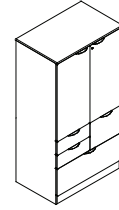

7-FCSJ-3621
(FJ/FCS Cabinet)

Double Height Cabinets

Item Number	List Price	Width (inches)	Depth (inches)	Height (inches)	Weight (lbs.)
7-FCSB-1821-L	1082	18	21	66	150
7-FCSB-1821-R	1082	18	21	66	150
7-FCSF-1821-L	1082	18	21	66	150
7-FCSF-1821-R	1082	18	21	66	150
7-FCSL-3021	1403	30	21	66	220
7-FCSL-3621	1536	36	21	66	240
7-FCSJ-3621	1562	36	21	66	240

Storage

Cabinets:

Includes lock

Will allow for either legal or letter filing

When Ordering Cabinets Please Specify:

Laminate color

Trim color

Sample Code

7	FCJL	36	21
Product Family	Product Code	Width	Depth

Panelink Storage

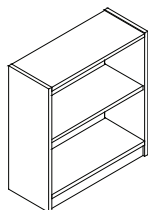

7-SB00-3042
(Book Case)

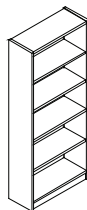

7-SB00-3066
(Double Height
Book Case)

Book Cases

Item Number	List Price	Width (inches)	Height (inches)	Depth (inches)	Weight (lbs.)
7-SB00-3042	414	30	42	12	70
7-SB00-3642	435	36	42	12	85
7-SB00-3066	559	30	66	12	110
7-SB00-3666	625	36	66	12	115

Storage

Book Cases:
Adjustable shelves
Installation hardware included

When Ordering Book Cases Please Specify:
Laminate color

Sample Code

7	SB00	36	42
Product Family	Product Code	Width	Height

Panelink Over Head Storage

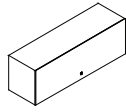

+

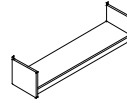
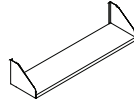

7-SOFC-1442
(Flipper Cabinet)

7-SOOM-1242
(Metal Shelf)

7-SOOL-1242
(Laminate Shelf)

Suspended Storage

Item Number	List Price	Depth (inches)	Width (inches)	Weight (lbs.)
7-SOFC-1430	435	14	30	32
7-SOFC-1436	468	14	36	35
7-SOFC-1442	493	14	42	39
7-SOFC-1448	514	14	48	43
7-SOFC-1454	524	14	54	46
7-SOFC-1460	561	14	60	49
7-SOOM-1230	118	12	30	13
7-SOOM-1236	132	12	36	15
7-SOOM-1242	147	12	42	16
7-SOOM-1248	162	12	48	18
7-SOOM-1254	167	12	54	20
7-SOOM-1260	170	12	60	22
7-SOOM-1266	177	12	66	23
7-SOOM-1272	183	12	72	25
7-SOOL-1224	179	12	24	10
7-SOOL-1230	187	12	30	11
7-SOOL-1236	203	12	36	13
7-SOOL-1242	216	12	42	14
7-SOOL-1248	238	12	48	16
7-SOOL-1254	248	12	54	17
7-SOOL-1260	269	12	60	18

Overhead Storage

Suspended Storage:

Installation hardware included
Provides extra storage space
Lock included

When Ordering Suspended Storage Please Specify:

Laminate color
Trim color
Metal color

Sample Code

7	SOFC	14	42
Product Family	Product Code	Depth	Width

Panelink Tack Boards

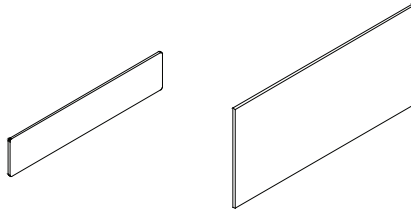

7-ATP0-1442
(14" Panel Mounted
Tackboard)

7-ATP0-2442
(24" Panel Mounted
Tackboard)

Tack Boards

Item Number	List Price	Height (inches)	Width (inches)	Weight (lbs.)
7-ATP0-1418	79	14	18	1
7-ATP0-1424	86	14	24	2
7-ATP0-1430	97	14	30	2
7-ATP0-1436	111	14	36	3
7-ATP0-1442	124	14	42	3
7-ATP0-1448	131	14	48	3
7-ATP0-1454	144	14	54	4
7-ATP0-1460	156	14	60	4
7-ATP0-2418	165	24	18	2
7-ATP0-2424	170	24	24	3
7-ATP0-2430	183	24	30	3
7-ATP0-2436	189	24	36	4
7-ATP0-2442	197	24	42	4
7-ATP0-2448	203	24	48	5
7-ATP0-2454	210	24	54	6
7-ATP0-2460	215	24	60	6

Tack Boards

Tack Boards:
Installation hardware included
Fabric wrapped

When Ordering Tack Boards Please Specify:

Fabric color
Trim color

Sample Code

7	ATP0	14	42
Product Family	Product Code	Height	Width

Sliding Doors, Glazed

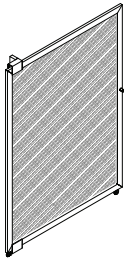

7-PDSG-6642-L
Left Hand Shown

Item Number	List Price	Height (inches)	Width (inches)
7-PDSG-6036-L	1127	60	36
7-PDSG-6042-L	1146	60	42
7-PDSG-6636-L	1140	66	36
7-PDSG-6642-L	1158	66	42
7-PDSG-6036-R	1127	60	36
7-PDSG-6042-R	1146	60	42
7-PDSG-6636-R	1140	66	36
7-PDSG-6642-R	1158	66	42

When Ordering Specify:
Glazing Colour • Panel Trim Colour

Application Notes:

Sliding Doors, Glazed

- Includes panel support hardware
- Frosted and Clear glazing have an upcharge of \$143
- Bronze and Fluted glazing have no upcharge

UNDERSTANDING THE PANELINK ELECTRICAL SYSTEM

A. THREE CIRCUIT SYSTEM

The 7 Wire 3 Circuit electrical system contains (3) circuits. Each circuit is rated at 15 amps/125 volts maximum. Circuit 1 and Circuit 2 are served by a system neutral and an equipment ground. Circuit 3 is shielded and isolated and is served by an isolated neutral and an isolated ground, making Circuit 3 both isolated and dedicated. Circuit 3 also includes a metallic shield against harmful electromagnetic interference (EMI). All conductors are #12 A.G.W. (gauge)

B. ISOLATED, DEDICATED & SHIELDED COMPUTER LINE

This means the computer line does not share cabling with the utility lines - it is specifically designated for computer use and the three wires of the computer line are separated from the other four by a foil shield. All of these precautions are to prevent power spikes on the other lines from affecting the computer.

C. TRIPLEX SYSTEM

As opposed to the conventional duplex system used in most wiring and panel systems, Tayco has a triplex system. Each triplex is removable and each triplex can access a designated circuit. You can have, for instance, one triplex feeding a computer, a task light and a laser printer, each on different circuits.

D. POWER HOOK-UP

The electrical starter harness has an open end with loose wires to be hooked up by the electrician. The starter harness is available in two lengths, a 72" length for floor and wall connections as well as a 168" length for ceiling power feeds.

The electrical current in the panel is only as reliable as the electrical connection. It is important that panel electrification is performed by a qualified electrician.

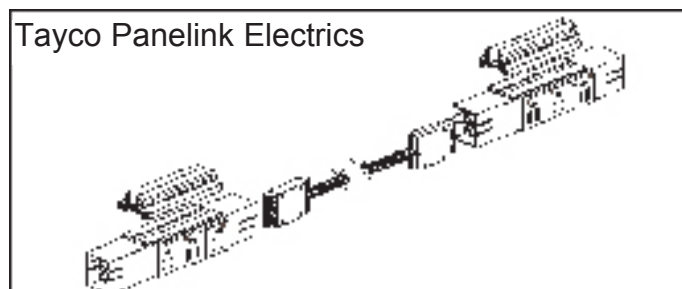

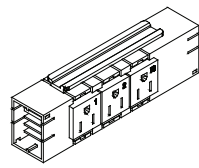

7-EM73-S
(Single Sided
Power Module)

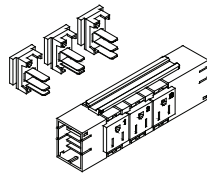

7-EM73-D
(Double Sided
Power Module)

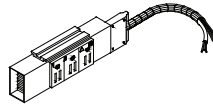

7-ES73-072-S
(Single Sided
Starter Harness)

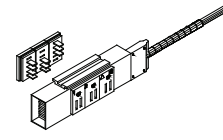

7-ES73-072-D
(Double Sided
Starter Harness)

Power Modules

Item Number	List Price	Length (inches)	Weight (lbs.)
7-EM73-S	81	7	1
7-EM73-D	122	7	1
7-ES73-072-S	223	72	2
7-ES73-168-S	333	168	5
7-ES73-072-D	263	72	2
7-ES73-168-D	375	168	5

Sample Code

7	ES73	072	D
Product Family	Product Code	Length	Product Modifier

**Power Connection
Harnesses**

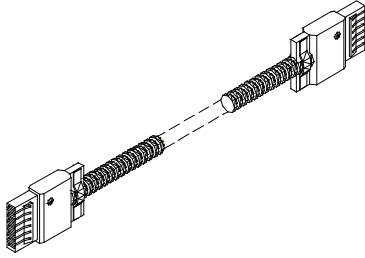

Item Number	List Price	Length (inches)	Weight (lbs.)
7-EH73-017	87	17	1
7-EH73-020	87	20	1
7-EH73-023	93	23	1
7-EH73-026	96	26	1
7-EH73-029	100	29	1
7-EH73-032	105	32	1
7-EH73-035	108	35	1
7-EH73-038	111	38	1
7-EH73-041	114	41	1
7-EH73-044	118	44	1
7-EH73-047	121	47	2
7-EH73-050	124	50	2
7-EH73-053	128	53	2
7-EH73-056	132	56	2
7-EH73-059	135	59	2
7-EH73-062	139	62	2
7-EH73-065	143	65	2
7-EH73-068	146	68	2
7-EH73-071	150	71	2
7-EH73-074	153	74	2
7-EH73-077	155	77	2
7-EH73-080	158	80	2
7-EH73-083	165	83	2
7-EH73-086	165	86	2
7-EH73-089	168	89	2
7-EH73-092	168	92	3
7-EH73-095	170	95	3
7-EH73-098	170	98	3
7-EH73-101	174	101	3
7-EH73-104	174	104	3
7-EH73-107	178	107	3
7-EH73-110	178	110	3
7-EH73-113	181	113	3
7-EH73-116	181	116	3
7-EH73-119	185	119	3
7-EH73-122	185	122	3
7-EH73-125	188	125	3
7-EH73-128	188	128	4
7-EH73-131	190	131	4
7-EH73-134	190	134	4
7-EH73-137	195	137	4
7-EH73-140	195	140	4
7-EH73-143	300	143	4
7-EH73-146	304	146	4
7-EH73-149	306	149	4
7-EH73-152	310	152	4
7-EH73-155	315	155	4
7-EH73-158	318	158	4
7-EH73-161	321	161	4
7-EH73-164	324	164	5
7-EH73-167	327	167	5

Electrics

Sample Code

7	EH73	072
Product Family	Product Code	Length

**Power Connection
Harnesses**

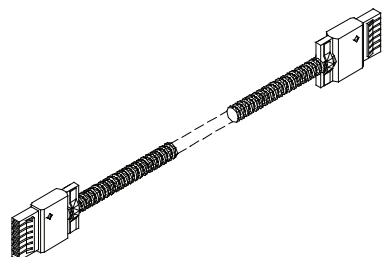

Item Number	List Price	Length (inches)	Weight (lbs.)
7-EH73-170	332	170	5
7-EH73-173	335	173	5
7-EH73-176	337	176	5
7-EH73-179	342	179	5
7-EH73-182	346	182	5
7-EH73-185	348	185	5
7-EH73-188	353	188	5
7-EH73-191	356	191	5
7-EH73-194	358	194	5
7-EH73-197	362	197	5
7-EH73-200	366	200	6
7-EH73-203	370	203	6
7-EH73-206	370	206	6
7-EH73-209	373	209	6
7-EH73-212	373	212	6
7-EH73-215	378	215	6
7-EH73-218	378	218	6
7-EH73-221	381	221	6
7-EH73-224	381	224	6
7-EH73-227	383	227	6
7-EH73-230	383	230	6
7-EH73-233	388	233	6
7-EH73-236	388	236	6
7-EH73-239	392	239	7
7-EH73-242	392	242	7
7-EH73-245	394	245	7
7-EH73-248	394	248	7
7-EH73-251	397	251	7
7-EH73-254	397	254	7
7-EH73-257	402	257	7
7-EH73-260	402	260	7

Electrics

Sample Code

7	EH73	248
Product Family	Product Code	Length



Type 1
RJ11/45

Type 2
RJ11/11/45

Type 3
RJ11/45/45

Communication Kits

Item Number	List Price
7-ECK1	98
7-ECK2	136
7-ECK3	147

Sample Code

7	ECK9
Product Family	Product Code

Panelink Wire Management



7-EPF0-144
(Fabric Wrapped
Power Pole)



7-EPV0-144
(Vinyl Power Pole)



7-EPVD-144
(Divided Vinyl
Power Pole)

Power Poles

Item Number	List Price	Height (inches)	Weight (lbs.)
7-EPF0-072	262	72	5
7-EPF0-144	327	144	10
7-EPV0-072	97	72	3
7-EPV0-144	197	144	6
7-EPVD-144	215	144	6
7-EPFD-144	347	144	10

Wire Management

Power Poles:

Available in three varieties
Power poles act as a effective way to run cabling to ceiling height

When specifying power poles please specify:

Fabric color
Vinyl color

Sample Code

7	EPF0	144
Product Family	Product Code	Height

Panelink Wire Management



7-EWVB-21
(Basic Vertical
Wire Manager)

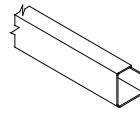

7-EWHB-12
(Basic Horizontal
Wire Manager)

Wire Managers

Item Number	List Price	Length (inches)	Weight (lbs.)
7-EWVB-21	16	21	0
7-EWHB-12	2	12	0
7-EWHB-24	4	24	0
7-EWHB-36	7	36	0

Power Poles:
Available in three varieties

Sample Code

7	EWHB	72
Product Family	Product Code	Length

Panelink Accessories

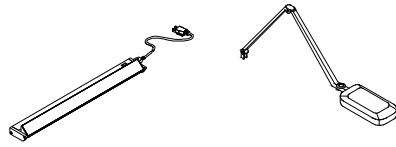

7-ELU-24
(Task Light)

7-ELSO
(Swing Arm Task Light)

Task Lighting

Item Number	List Price	Width (inches)	Weight (lbs.)	Cord Length
7-ELU-24	114	24	9.50	9
7-ELU-36	128	36	13.70	9
7-ELU-48	136	48	17.90	9
7-ELSO	402		5	9

Task Lighting:

Available only in silver

Sample Code

7	ELU	48
Product Family	Product Code	Length

Panelink Accessories

Double Channel Wall Bracket*

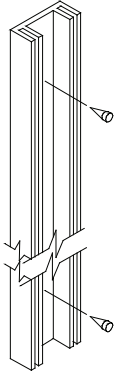

* Order the Double Channel Wall Mounted Bracket Kit to be the same size as the flipper cabinet that it will support.

Item Number	List Price	Height (inches)	Weight (lbs.)
7-ADWB-24-KIT	65	24	1
7-ADWB-30-KIT	80	30	2
7-ADWB-36-KIT	98	36	2
7-ADWB-42-KIT	116	42	2
7-ADWB-48-KIT	132	48	2
7-ADWB-54-KIT	149	54	3
7-ADWB-60-KIT	166	60	3

Double Channel Wall Bracket:
Extruded aluminum construction
Wall mounting hardware included

When Specifying Double Channel Wall Bracket Please Specify:
Metal color

Sample Code

7	EPF0	144
Product Family	Product Code	Height

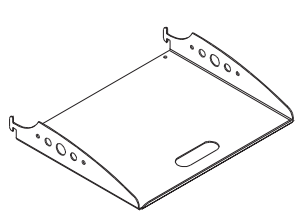

AALT

Paper Tray
Letter Size: 10" x 12"

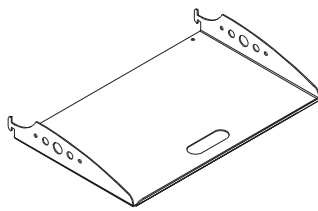

AALG

Paper Tray
Legal Size: 10" x 15"

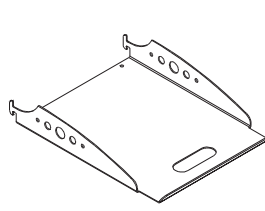

AATT

Phone Tray
10" x 9"

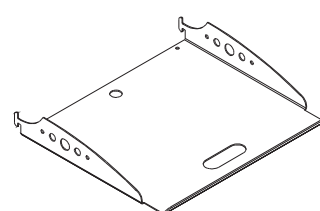

AATT

Phone Tray
10" x 13"

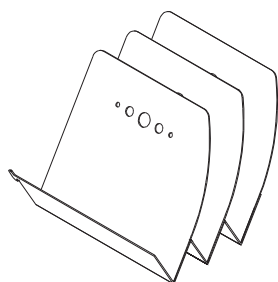

AA3D

Document Sorter

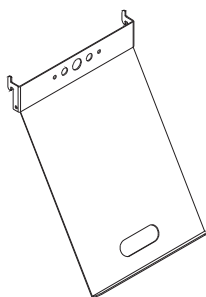

AAE0

Paper Easel

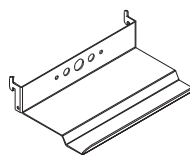

AAPT

Pen / Clip Tray
5" x 9"

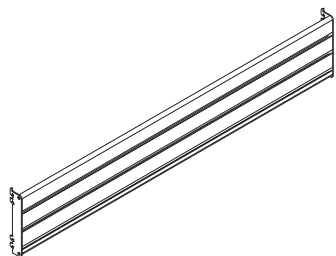

AAB0

Accessory Bar

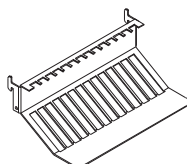

AAM0

Multimedia Organizer

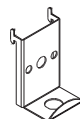

AAH0

Headset / Photo Holder

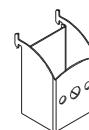

AAP0

Pencil Holder

Accessories

Application Notes:

When Ordering Please Specify:
File Bar and Accessory Colour

How To Specify Accessories

7	AAE0
Product Family	Product Code

Accessory Bar

Item Number	List Price	Length (inches)	Weight (lbs.)
7-AAB0-18	100	18	2
7-AAB0-24	112	24	2
7-AAB0-30	122	30	2
7-AAB0-36	138	36	2
7-AAB0-42	144	42	3
7-AAB0-48	156	48	3
7-AAB0-54	171	54	3
7-AAB0-60	187	60	4
7-AAB0-66	202	66	4
7-AAB0-72	215	72	4

File Bar Accessories

Item Number	List Price	Weight (lbs.)	Description
7-AAP0	68	1	Pencil Holder
7-AALT	72	3	Paper Tray, Letter Size, 10" x 12"
7-AALG	75	3	Paper Tray, Legal Size, 10" x 15"
7-AATT-09	70	3	Telephone Tray, 10" x 9"
7-AATT-13	73	3	Telephone Tray, 10" x 13"
7-AA3D	138	3	Paper Sorter
7-AAM0	62	3	Multimedia Organizer
7-AAPT	57	3	Pen/Clip Tray, 5" x 9"
7-AAE0	57	3	Paper Easel
7-AAH0	49	3	Headset Holder

When Ordering Accessories Please Specify:
Metal color

Sample Code

7	AALT
Product Family	Product Code

Panelink Accessories

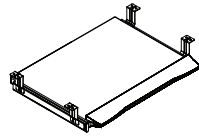

7-KRS0-2516
(Retractable Keyboard)

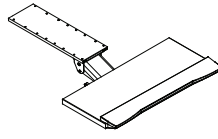

7-KAS0-2510
(Articulating Keyboard)

Keyboard Trays

Item Number	List Price	Length (inches)	Width (inches)	Weight (lbs.)
7-KRS0-2516	76	25	16	7
7-KAS0-2510	266	25	10	15

When Ordering Keyboard Trays Please Specify:

Laminate color
Trim color

Sample Code

7	KRSO	25	16
Product Family	Product Code	Width	Depth

CPU Holder

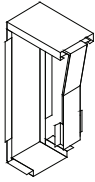

7-ACPU
(CPU Holder)

Item Number	List Price	Height (inches)	Width (inches)	Weight (lbs)
7-ACPU	196	8		

CPU Holder:
Available in black only
Adjusts to fit most computers

Grommet Style Monitor Arm

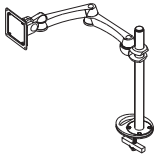

7-AFMA-G
Grommet Style Monitor Arm

Item Number	List Price	Height (inches)	Width (inches)	Weight (lbs)
7-AFMA-G	326	16	5-20	10

Available in only in Silver

Clamp Style Monitor Arm

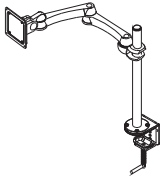

7-AFMA-C
Clamp Style Monitor Arm

Item Number	List Price	Height (inches)	Width (inches)	Weight (lbs)
7-AFMA-C	326	16	5-20	10

Available only in Silver

Sample Code

7	ACPU
Product Family	Product Code

tayco.
work well.™

office furniture
in your comfort zone.
www.tayco.com



WORK WELL IS A TRADEMARK OF TAYCO PANELINK LTD. ALL RIGHTS RESERVED.
TEKNIT™ IS A TRADEMARK OF INTERFACE FABRICS, INC., AN INTERFACE COMPANY.
MAY 2011 | REVISION 4 | TPL-MKT-02-349
PRINTED IN CANADA